



РУКОВОДСТВО
ПО ЭКСПЛУАТАЦИИ
Индукционные
электродвигатели
и мотор-редукторы
с тормозом

无励磁动作型电磁制动电动机

POWER OFF ACTIVATED TYPE ELECTROMAGNETIC BRAKE MOTOR

■ 6W □ 60mm



规格 Specs / 电动机 Motor

- 没有内藏简易制动 This type of motor does not contain a built-in simple brake mechanism.

型号 Model · 类型 Type 导线型 Lead Wire Type		额定 Rating	输出功率 Output power	电压 Voltage	频率 Frequency	电流 Current	启动转矩 Starting Torque	额定转矩 Rated Torque	额定转速 Rated Speed	电容器容量 Capacitor
齿轮轴型 Pinion Shaft	圆轴型 Round Shaft									
2RK6GN-AM	2RK6A-AM	30min	6	1ph 100	50	0.265	60	48	1200	4.0
					60	0.232	55	40	1450	
2RK6GN-EM	2RK6A-EM	30min	6	1ph 110	60	0.185	45	40	1450	2.5
				1ph 120		0.200				
2RK6GN-CM	2RK6A-CM	30min	6	1ph 220	50	0.145	55	48	1200	1.0
				1ph 230		0.150				
2RK6GN-HM	2RK6A-HM	30min	6	1ph 220	60	0.145	60	40	1450	-
				1ph 230		0.150				
2RK6GN-SM	2RK6A-SM	30min	6	3ph 220	50	0.076	85	48	1200	-
					60	0.065	70	40	1450	

- 各种安全规格以电动机铭牌上的型号取得认定。

When the motor is approved under various safety standards, the model name on the nameplate is the approved model name.

- (T): 内藏热保护装置 (自动复位型)。在电动机因某种原因过热时会自行起动作使电动机停止。
Contains a built-in thermal protector (automatic return). If a motor overheats for any reason, the thermal protector is opened and the motor stops.
- 电动机温度下降后会自行恢复运行，故在进行检查作业时请务必事先切断电源。
When the motor temperature drops, the thermal protector closes and the motor restarts. Be sure to turn the motor off before inspecting.
- 注：“-A”型号中电压为110V时，配置电容器容量以实际铭牌为准。
Note:“-A” it means the voltage 110v, the assembly capacitor vaule it is according the labe.

种类 Type

- 电动机 Motor

机型 Type	型号 Model	
	齿轮轴型 Pinion Shaft	圆轴型 Round Shaft
导线型 Lead Wire Type	2RK6GN-AM	2RK6A-AM
	2RK6GN-EM	2RK6A-EM
	2RK6GN-CM	2RK6A-CM
	2RK6GN-HM	2RK6A-HM
	2RK6GN-SM	2RK6A-SM

- 平行轴减速器 (另售) Parallel Shaft Gearhead (Sold Separately)

减速器种类 Gearhead Type	减速器型号 Gearhead Model	减速比 Gear Ratio
长寿命●低噪音 Long Life ● Low Noise	2GN□K	3、3.6、5、6、7.5、9、 12.5、15、18、25、30、 36、50、60、75、90、 100、120、150、180、200
	2GN10XK (中间减速器 Decimal Gearhead)	

- 减速器型号的□中为减速比的数值
Enter the gear ratio in the box (□) within the model name

■ 装有减速器时的容许转矩 Gear Motor-Torque Table

- 减速器另售·中间减速器另售。
Gearhead and mid-gearbox can be sold separately.
- 减速品型号的□中为减速比的数值。
Enter the gear ratio in the box(□) within the model name.
- □色表示与电动机同一方向运转，其他则为相反方向。
The colored background □ indicates the same rotating direction of the motor while the rotating direction of others are opposite.
- 转速是以电动机的同步转速 (50Hz : 1500r/min、60Hz : 1800r/min) 为基准除以减速比而算出来的数值。实际转速将随负载大小变化所示数值减少2%~20%左右。
The speed is calculated by dividing the motor's synchronous speed (50Hz : 1500r/min、60Hz : 1800r/min) by the gear ratio. The actual speed is 2%~20% less than the displayed value, depending on the size of the load.
- 希望以大于下表的减速比进行进一步减速时，可在电动机与减速机之间安装减速比为10的中间减速机。这时的容许转矩为3N·m。
To reduce the speed beyond the gear ratio in the table, attach a decimal gearhead(gear ratio:10)between the gearhead and motor. In that case, the permissible torque is 3 N·m.

■ 容许力矩单位 Allowance Torque Unit : 上段 Upside (N.m) /下段 Belowside (kgf.cm)

类型 Type 电动机/减速机 Motor/Gearhead	减速比 Gear Ratio		3	3.6	5	6	7.5	9	12.5	15	18	25	30	36	50	60	75	90	100	120	150	180	200
	转速 Speed r/min	50Hz	500	417	300	250	200	166	120	100	83	60	50	41	30	25	20	16	15	12.5	10	8.3	7.5
		60Hz	600	500	360	300	240	200	144	120	100	72	60	50	36	30	24	20	18	15	12	10	9
2RK6GN-AM 2RK6GN-EM 2RK6GN-CM 2RK6GN-HM 2RK6GN-SM	2GN□K	50Hz	0.12	0.14	0.19	0.23	0.29	0.35	0.49	0.58	0.70	0.88	1.1	1.3	1.6	1.9	2.4	2.9	3	3	3	3	3
		60Hz	1.22	1.43	1.94	2.35	2.96	3.57	5.0	5.92	7.14	8.98	11.2	13.3	16.3	19.4	24.5	29.6	30	30	30	30	30
		50Hz	0.10	0.12	0.16	0.19	0.24	0.29	0.41	0.49	0.58	0.73	0.88	1.1	1.3	1.6	2.0	2.4	2.6	3	3	3	3
		60Hz	1.02	1.22	1.63	1.94	2.45	2.96	4.18	5.0	5.92	7.45	8.98	11.2	13.3	16.3	20.4	24.5	26.5	30	30	30	30

■ 容许悬挂负载 · 容许轴向负载 To Allow The Hoisting Of The Load Allow Axial Load

电动机 (圆轴型) → 272页 Motor(Round Shaft) → P272
 减速机 → 272页 Gearhead → P272

■ 减速机的容许负载惯性惯量 J Permissible Load Inertia J For Gearhead

→ 272页 → P272

■ 启动、制动特性 (参考值) Starting And Brake Characteristics(Reference Values)

- 单相电动机 Single-phase Motor
- 三相电动机 Three-phase Motor

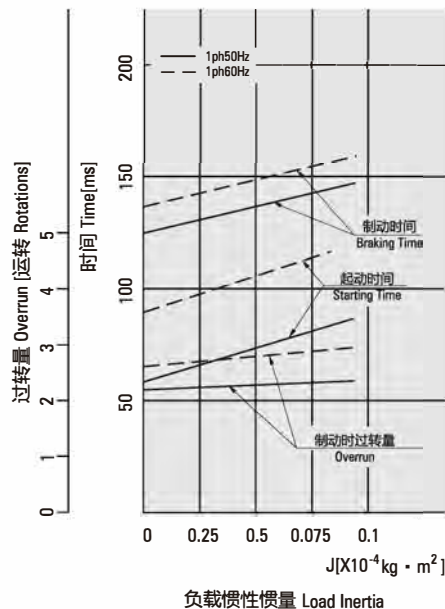
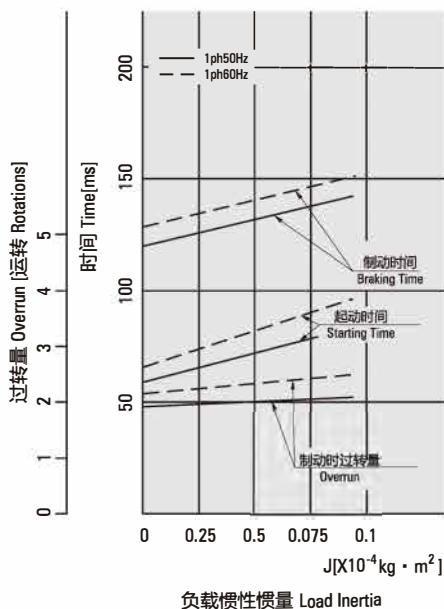

外形图 (单位 mm) Dimensions(Unit mm)

减速器附有安装用螺丝 Mounting screws are included with gearhead.

● 导线型 Lead Wiring Type

重量 Weight : 电动机 Motor : 1.1kg

减速器 Gearhead : 0.4kg

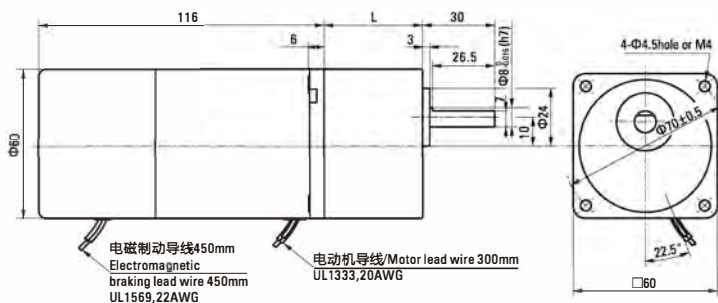

电动机型号 Motor Model	减速器型号 Gearhead Model	减速比 Gear Ratio	L1
2RK6GN-AM	2GN□K	3~18	32
2RK6GN-EM			
2RK6GN-CM		25~200	
2RK6GN-HM			
2RK6GN-SM			

● 减速器型号的□中为减速比的数值

Enter the gear ratio in the box (□) within the model name

● 圆轴型的转轴部分 Shaft Section Of Round Shaft Type

除重量及轴部外电动机外形与齿轮轴型相同。

Excluding weight and the shaft section motor shape are the same as those of the pinion shaft type.

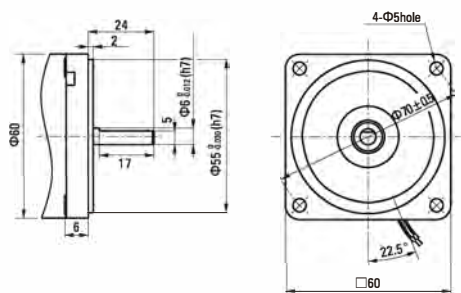

● 中间减速器 Decimal Gearhead

可安装在GN齿轮轴型上 Can be connected to GN pinion shaft type

电动机外形与齿轮轴型相同

3GN10XK

重量 Weight : 0.3kg

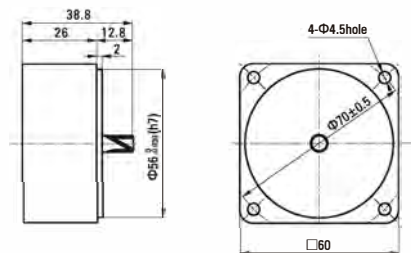

电容器外形尺寸 Formal Dimension Of Capacitor

型号 Model		电容器型号 Capacitor Model	L	W	H
齿轮轴型 Pinion Shaft	圆轴型 Round Shaft				
2RK6GN-AM	2RK6A-AM	ZD40CFAUL	47	17	31
2RK6GN-EM	2RK6A-EM	ZD25CFAUL	38	17	28
2RK6GN-CM	2RK6A-CM	ZD10BFAUL	36	11	22

● 常规电容器出线为引线,也可根据客户要求配置插片式187#

Note: Conventional capacitor is a lead wire type. Inserted 187# is optional

● 电动机型号的中□为表示带端子的记号 (T)

Enter the code that represents the terminal box type (T) in the box (□) within the model name

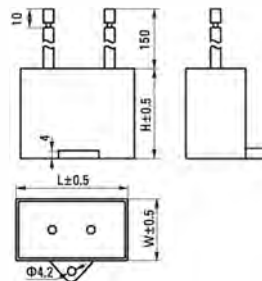

连接图 Wiring Diagram

●运转方向指从电动机轴看来的方向。CW表示顺时针方向，CCW表示逆时针方向。

The direction of motor rotation is as viewed from the shaft end of motor. CW represents the clockwise direction, while CCW represents the counterclockwise direction.

●表中所记品名为齿轮轴型，圆轴型亦同。Name indicated in the list is pinion shaft type, also valid for the equivalent round shaft type.

单相电动机 Single-phase Motor	
2RK6GN-AM、2RK6GN-EM、2RK6GN-CM、2RK6GN-HM	

SW1为电动机的运行/停止及电磁制动操作作用开关。(联动)

SW1 operates both motor and electromagnetic brake action. (Switched Simultaneously)

SW1设定于ON时，电磁制动解除，电动机开始运行。

The motor will rotate when SW1 is switched simultaneously to ON.

SW1设定于OFF时，电动机停止，电磁制动开始工作。

When SW1 is switched simultaneously to OFF, the motor stops immediately with the electromagnetic brake and holds the load.

在电动机停止状态下解除电磁制动时，应将SW1设定为非联动，而仅将黑色导线侧的触点设定为ON。

If you wish to release the brake while the motor is stopped, set the SW1 to off and connection point at the side of black lead to on.

运转方向。Direction of Rotation.

将SW2转换至CW侧时，电动机作顺时针方向运转。

To rotate the motor in a clockwise (CW) direction, turn SW2 to CW.

将SW2转换至CCW侧时，电动机作逆时针方向运转。

To rotate the motor in a counterclockwise (CCW) direction, turn SW2 to CCW.

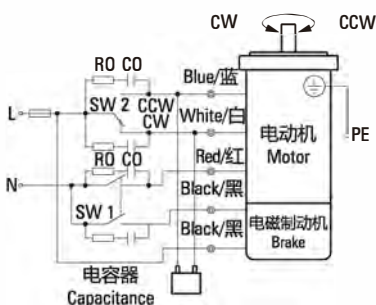

开关 号码 Switch No.	开关的触点容量Capacitor of Switch Connection Point		参考 Note
	单相100V、 110/120V输入 Single-Phase 100 VAC, 110/115 VAC Input	单相220V、 230V输入 Single-Phase 200 VAC, 220/230 VAC Input	
SW1	AC125V 3A以上 (感应负载) 125 VAC 3A minimum (Inductive Load)	AC250V 1.5A以上 (感应负载) 250 VAC 1.5A A minimum (Inductive Load)	联动Switched Simultaneously
SW2			

三相电动机 Three-phase Motor	
2IK6GN-SM	

SW1为电动机的运行/停止及电磁制动操作作用开关。(联动)

SW1 operates both motor and electromagnetic brake action. (Switched Simultaneously)

SW1设定于ON时，电磁制动解除，电动机开始运行。

The motor will rotate when SW1 is switched simultaneously to ON.

SW1设定于OFF时，电动机停止，电磁制动开始工作。

When SW1 is switched simultaneously to OFF, the motor stops immediately with the electromagnetic brake and holds the load.

在电动机停止状态下解除电磁制动时，应将SW1设定为非联动，而仅将黑色导线侧的触点设定为ON。

If you wish to release the brake while the motor is stopped, set the SW1 to off and connection point at the side of black lead to on.

运转方向。Direction of Rotation.

若对换R、S、T中任意二条，电动机逆时针方向运转。

To change the rotation direction, change any two connections between R, S and T.

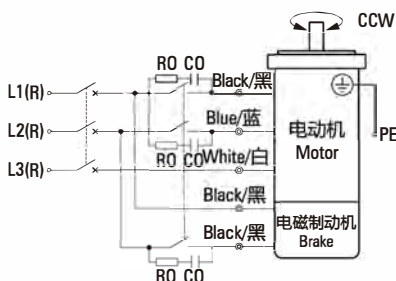

开关 号码 Switch No.	开关的触点容量Capacitor of Switch Connection Point		参考 Note
SW1	AC250V 1.5A以上 (感应负载) 250 VAC 1.5 A minimum (Inductive Load)		联动 Switched Simultaneously

请注意Notes:

●ROCO为吸收电涌电压用CR电路。[R0=5~200Ω、C0=0.1~0.2μF、200WV (400WV)] 请使用选购配件EPCR1201-2。

●R0 and C0 indicate surge suppressor circuit. [R0=5~200Ω, C0=0.1~0.2 μ F, 200 WV (400 WV)] EPCR1201-2 is available as an optional surge suppressor.

无励磁动作型电磁制动电动机 POWER OFF ACTIVATED TYPE ELECTROMAGNETIC BRAKE MOTOR

■15W □70mm



规格 Specs / 电动机 Motor

- 没有内藏简易制动 This type of motor does not contain a built-in simple brake mechanism.

型号Model · 类型 Type 导线型 Lead Wire Type		额定 Rating	输出功率 Output power	电压 Voltage	频率 Frequency	电流 Current	启动转矩 Starting Torque	额定转矩 Rated Torque	额定转速 Rated Speed	电容器容量 Capacitor
齿轮轴型 Pinion Shaft	圆轴型 Round Shaft									
3RK15GN-AM	3RK15A-AM	30min	15	1ph 100	50	0.40	110	125	1200	7.0
					60	0.56	105	105	1450	
3RK15GN-EM	3RK15A-EM	30min	15	1ph 110	60	0.43	85	105	1450	6.0
				1ph 120		0.42				
3RK15GN-CM	3RK15A-CM	30min	15	1ph 220	50	0.23	110	125	1200	1.5
				1ph 230						
3RK15GN-HM	3RK15A-HM	30min	15	1ph 220	60	0.20	85	105	1450	1.5
				1ph 230			90			
3RK15GN-SM	3RK15A-SM	30min	15	3ph 220	50	0.14	220	125	1200	1.5
					60	0.12	180	105	1450	

- 各种安全规格以电动机铭牌上的型号取得认定。

When the motor is approved under various safety standards, the model name on the nameplate is the approved model name.

- (D): 内藏热保护装置 (自动复位型)。在电动机因某种原因过热时会自行起动作使电动机停止。
Contains a built-in thermal protector (automatic return). If a motor overheats for any reason, the thermal protector is opened and the motor stops.
- 电动机温度下降后会自动恢复运行，故在进行检查作业时请务必先切断电源。
When the motor temperature drops, the thermal protector closes and the motor restarts. Be sure to turn the motor off before inspecting.
- 注：“-A”型号中电压为110V时，配置电容器容量以实际铭牌为准。
Note:“-A” it means the voltage 110v, the assembly capacitor value it is according to the label.

种类 Type

- 电动机 Motor

机型 Type	型号Model	
	齿轮轴型 Pinion Shaft	圆轴型 Round Shaft
导线型 Lead Wire Type	3RK15GN-AM	3RK15A-AM
	3RK15GN-EM	3RK15A-EM
	3RK15GN-CM	3RK15A-CM
	3RK15GN-HM	3RK15A-HM
	3RK15GN-SM	3RK15A-SM

- 平行轴减速器 (另售) Parallel Shaft Gearhead (Sold Separately)

减速器种类 Gearhead Type	减速器型号 Gearhead Model	减速比 Gear Ratio
长寿命●低噪音 Long Life ● Low Noise	3GN□K	3、3.6、5、6、7.5、9、 12.5、15、18、25、30、 36、50、60、75、90、 100、120、150、180、200
	3GN10XK (中间减速器Decimal Gearhead)	

- 减速器型号的□中为减速比的数值
Enter the gear ratio in the box (□) within the model name

■ 装有减速器时的容许转矩 Gear Motor-Torque Table

- 减速器另售·中间减速器另售。
Gearhead and mid-gearbox can be sold separately.
- 减速品型号的□中为减速比的数值。
Enter the gear ratio in the box(□) within the model name.
- □色表示与电动机同一方向运转，其他则为相反方向。
The colored background □ indicates the same rotating direction of the motor while the rotating direction of others are opposite.
- 转速是以电动机的同步转速 (50Hz : 1500r/min、60Hz : 1800r/min) 为基准除以减速比而算出来的数值。实际转速将随负载大小变化所示数值减少2%~20%左右。
The speed is calculated by dividing the motor's synchronous speed (50Hz : 1500r/min、60Hz : 1800r/min) by the gear ratio. The actual speed is 2%~20% less than the displayed value, depending on the size of the load.
- 希望以大于下表的减速比进行进一步减速时，可在电动机与减速机之间安装减速比为10的中间减速机。这时的容许转矩为5N·m。
To reduce the speed beyond the gear ratio in the table, attach a decimal gearhead(gear ratio:10)between the gearhead and motor. In that case, the permissible torque is 5 N·m.

■ 容许力矩单位 Allowance Torque Unit : 上段 Upside (N.m) /下段 Belowside (kgf.cm)

类型 Type 电动机/减速机 Motor/Gearhead	减速比 Gear Ratio		3	3.6	5	6	7.5	9	12.5	15	18	25	30	36	50	60	75	90	100	120	150	180	200
	转速 Speed r/min	50Hz	500	417	300	250	200	166	120	100	83	60	50	41	30	25	20	16	15	12.5	10	8.3	7.5
		60Hz	600	500	360	300	240	200	144	120	100	72	60	50	36	30	24	20	18	15	12	10	9
3RK15GN-AM 3RK15GN-EM 3RK15GN-CM 3RK15GN-HM 3RK15GN-SM	3GN□K	50Hz	0.30	0.36	0.51	0.61	0.76	0.91	1.3	1.5	1.8	2.3	2.7	3.3	4.1	5	5	5	5	5	5	5	5
			3.06	3.67	5.20	6.22	7.75	9.28	13.2	15.3	18.3	23.4	27.5	33.7	41.8	50	50	50	50	50	50	50	50
		60Hz	0.26	0.31	0.43	0.51	0.64	0.77	1.1	1.3	1.5	1.9	2.3	2.8	3.5	4.2	5	5	5	5	5	5	5
			2.65	3.16	4.38	5.20	6.53	7.85	11.2	13.2	15.3	19.3	23.4	28.5	35.7	42.8	50	50	50	50	50	50	50

■ 容许悬挂负载 · 容许轴向负载 To Allow The Hoisting Of The Load Allow Axial Load

电动机 (圆轴型) → 272页 Motor(Round Shaft) → P272
减速机 → 272页 Gearhead → P272

■ 减速机的容许负载惯性惯量 J Permissible Load Inertia J For Gearhead

→ 272页 → P272

■ 启动、制动特性 (参考值) Starting And Brake Characteristics(Reference Values)

- 单相电动机 Single-phase Motor
- 三相电动机 Three-phase Motor

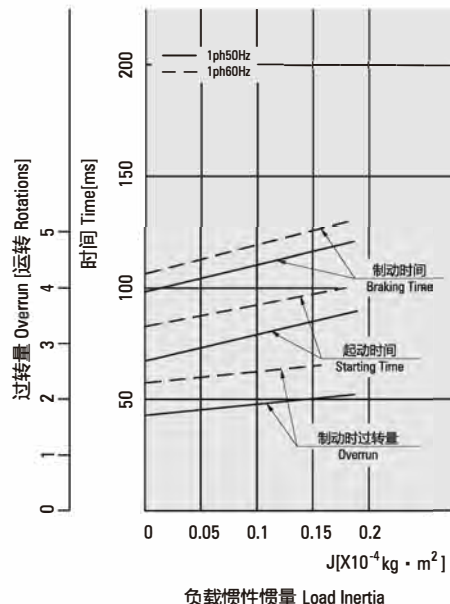
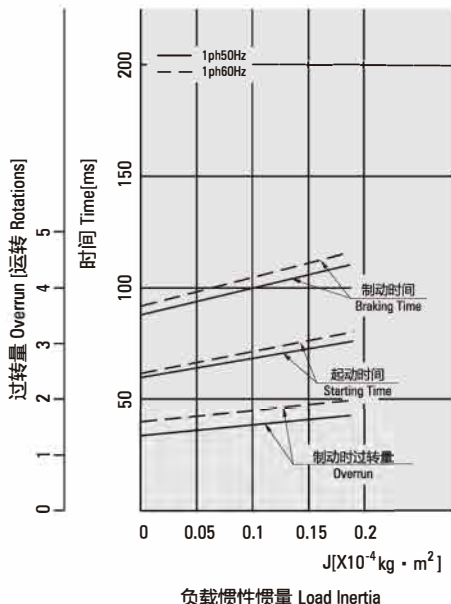

外形图 (单位 mm) Dimensions(Unit mm)

减速器附有安装用螺丝 Mounting screws are included with gearhead.

导线型 Lead Wiring Type

重量 Weight : 电动机 Motor : 1.47kg

减速器 Gearhead : 0.5kg

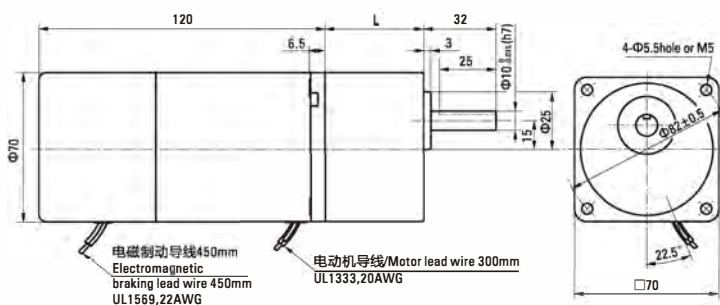

电动机型号 Motor Model	减速器型号 Gearhead Model	减速比 Gear Ratio	L1
3RK15GN-AM	3GN□K	3~18	32
3RK15GN-EM			
3RK15GN-CM		25~200	42
3RK15GN-HM			
3RK15GN-SM			

减速器型号的□中为减速比的数值

Enter the gear ratio in the box (□) within the model name

键·键槽 (减速器附件) Key·Keyway(Accessory Of Gearhead)

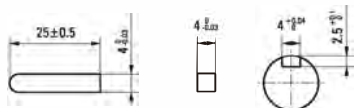

圆轴型的转轴部分 Shaft Section Of Round Shaft Type

除重量及轴部外电动机外形与齿轮轴型相同。

Excluding weight and the shaft section motor shape are the same as those of the pinion shaft type.

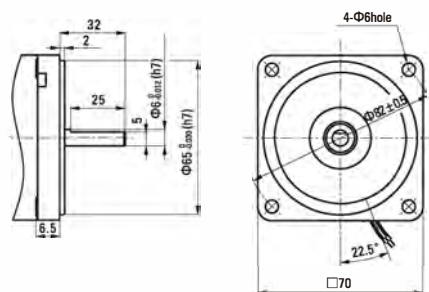

中间减速器 Decimal Gearhead

可安装在GN齿轮轴型上 Can be connected to GN pinion shaft type

电动机外形与齿轮轴型相同

3GN10XK

重量 Weight : 0.3kg

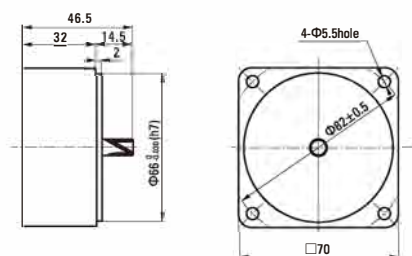

电容器外形尺寸 Formal Dimension Of Capacitor

型号 Model		电容器型号 Capacitor Model	L	W	H
齿轮轴型 Pinion Shaft	圆轴型 Round Shaft				
3RK15GN-AM	3RK15A-AM	ZD70CFAUL	47	24	37
3RK15GN-EM	3RK15A-EM	ZD60CFAUL	48	23	32
3RK15GN-CM	3RK15A-CM	ZD15BFAUL	36	12.5	24

常规电容器出线为引线,也可根据客户要求配置插片式187#

Note: Conventional capacitor is a lead wire type. Inserted 187# is optional

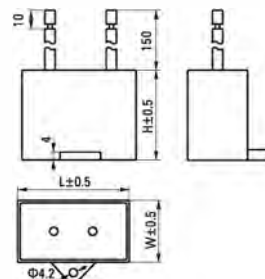

连接图 Wiring Diagram

●运转方向指从电动机轴看来的方向。CW表示顺时针方向，CCW表示逆时针方向。

The direction of motor rotation is as viewed from the shaft end of motor. CW represents the clockwise direction, while CCW represents the counterclockwise direction.

●表中所记品名为齿轮轴型，圆轴型亦同。Name indicated in the list is pinion shaft type, also valid for the equivalent round shaft type.

单相电动机 Single-phase Motor	
3RK15GN-AM、3RK15GN-EM、3RK15GN-CM、3RK15GN-HM	

SW1为电动机的运行/停止及电磁制动操作作用开关。（连动）

SW1 operates both motor and electromagnetic brake action. (Switched Simultaneously)

SW1设定于ON时，电磁制动解除，电动机开始运行。

The motor will rotate when SW1 is switched simultaneously to ON.

SW1设定于OFF时，电动机停止，电磁制动开始工作。

When SW1 is switched simultaneously to OFF, the motor stops immediately with the electromagnetic brake and holds the load.

在电动机停止状态下解除电磁制动时，应将SW1设定为非连动，而仅将黑色导线侧的触点设定为ON。

If you wish to release the brake while the motor is stopped, set the SW1 to off and connection point at the side of black lead to on.

运转方向。Direction of Rotation.

将SW2转换至CW侧时，电动机作顺时针方向运转。

To rotate the motor in a clockwise (CW) direction, turn SW2 to CW.

将SW2转换至CCW侧时，电动机作逆时针方向运转。

To rotate the motor in a counterclockwise (CCW) direction, turn SW2 to CCW.

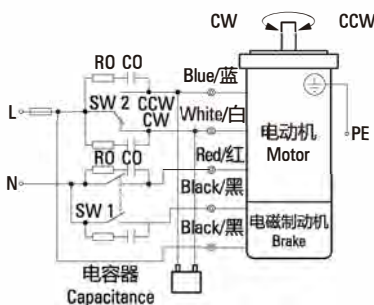

开关 号码 Switch No.	开关的触点容量Capacitor of Switch Connection Point		参考 Note
	单相100V、 110/120V输入 Single-Phase 100 VAC, 110/120 VAC Input	单相220V、 230V输入 Single-Phase 200 VAC, 220/230 VAC Input	
SW1	AC125V 8A以上 (感应负载) 125 VAC 8A minimum (Inductive Load)	AC250V 8A以上 (感应负载) 250 VAC 8A A minimum (Inductive Load)	连动Switched Simultaneously
SW2			

三相电动机 Three-phase Motor	
3RK15GN-SM	

SW1为电动机的运行/停止及电磁制动操作作用开关。（连动）

SW1 operates both motor and electromagnetic brake action. (Switched Simultaneously)

SW1设定于ON时，电磁制动解除，电动机开始运行。

The motor will rotate when SW1 is switched simultaneously to ON.

SW1设定于OFF时，电动机停止，电磁制动开始工作。

When SW1 is switched simultaneously to OFF, the motor stops immediately with the electromagnetic brake and holds the load.

在电动机停止状态下解除电磁制动时，应将SW1设定为非连动，而仅将黑色导线侧的触点设定为ON。

If you wish to release the brake while the motor is stopped, set the SW1 to off and connection point at the side of black lead to on.

运转方向。Direction of Rotation.

若对换R、S、T中任意二条，电动机逆时针方向运转。

To change the rotation direction, change any two connections between R, S and T.

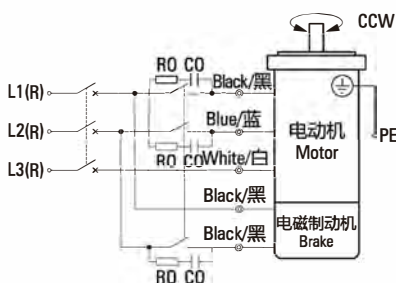

开关 号码 Switch No.	开关的触点容量Capacitor of Switch Connection Point	参考 Note
SW1	AC250V 1.5A以上 (感应负载) 250 VAC 1.5 A minimum (Inductive Load)	连动 Switched Simultaneously

请注意Notes:

●ROCO为吸收电涌电压用CR电路。[R0=5~200Ω、C0=0.1~0.2μF、200WV (400WV)] 请使用选购配件EPCR1201-2。

●R0 and C0 indicate surge suppressor circuit. [R0=5~200Ω, C0=0.1~0.2 μ F, 200 WV (400 WV)] EPCR1201-2 is available as an optional surge suppressor.

无励磁动作型电磁制动电动机

POWER OFF ACTIVATED TYPE ELECTROMAGNETIC BRAKE MOTOR

■ 25W □ 80mm



规格 Specs / 电动机 Motor

- 没有内藏简易制动 This type of motor does not contain a built-in simple brake mechanism.

型号 Model · 类型 Type 导线型 Lead Wire Type		额定 Rating	输出功率 Output power	电压 Voltage	频率 Frequency	电流 Current	启动转矩 Starting Torque	额定转矩 Rated Torque	额定转速 Rated Speed	电容器容量 Capacitor
齿轮轴型 Pinion Shaft	圆轴型 Round Shaft									
4RK25GN-AM	4RK25A-AM	30min	25	1ph 100	50	0.59	160	200	1250	10.0
					60	0.69	140	165	1550	
4RK25GN-EM	4RK25A-EM	30min	25	1ph 110	60	0.45	140	165	1550	8.0
				1ph 120		0.50				
4RK25GN-CM	4RK25A-CM	30min	25	1ph 220	50	0.29	140	200	1250	2.2
				1ph 230		0.30				
4RK25GN-HM	4RK25A-HM	30min	25	1ph 220	60	0.35	140	165	1550	-
				1ph 230						
4RK25GN-SM	4RK25A-SM	30min	25	3ph 220	50	0.185	350	200	1250	-
					60	0.170	250	165	1550	

- 各种安全规格以电动机铭牌上的型号取得认定。
When the motor is approved under various safety standards, the model name on the nameplate is the approved model name.
- (D): 内藏热保护装置 (自动复位型)。在电动机因某种原因过热时会自行起动作使电动机停止。
Contains a built-in thermal protector(automatic return). If a motor overheats for any reason, the thermal protector is opened and the motor stops.
- 电动机温度下降后会自行恢复运行, 故在进行检查作业时请务必事先切断电源。
When the motor temperature drops, the thermal protector closes and the motor restarts. Be sure to turn the motor off before inspecting.
- 注: "-A" 型号中电压为110V时, 配置电容器容量以实际铭牌为准。
Note: "-A" it means the voltage 110v,the assembly capacitor vaule it is according the labe.

种类 Type

- 电动机 Motor

机型 Type	型号 Model	
	齿轮轴型 Pinion Shaft	圆轴型 Round Shaft
导线型 Lead Wire Type	4RK25GN-AM	4RK25A-AM
	4RK25GN-EM	4RK25A-EM
	4RK25GN-CM	4RK25A-CM
	4RK25GN-HM	4RK25A-HM
	4RK25GN-SM	4RK25A-SM

- 平行轴减速器 (另售) Parallel Shaft Gearhead (Sold Separately)

减速器种类 Gearhead Type	减速器型号 Gearhead Model	减速比 Gear Ratio
长寿命●低噪音 Long Life ● Low Noise	4GN□K	3、3.6、5、6、7.5、9、 12.5、15、18、25、30、 36、50、60、75、90、 100、120、150、180、200
	4GN10XK (中间减速器 Decimal Gearhead)	

- 减速器型号的□中为减速比的数值
Enter the gear ratio in the box (□) within the model name

■ 装有减速器时的容许转矩 Gear Motor-Torque Table

- 减速器另售·中间减速器另售。电动机型号的□中为表示带端子箱型的记号(T)。
Gearhead and mid-gearbox can be sold separately. Enter the code that represents the terminal box type (T) in the box (□) within the model name.
- 减速品型号的□中为减速比的数值。
Enter the gear ratio in the box(□) within the model name.
- □色表示与电动机同一方向运转，其他则为相反方向。
The colored background □ indicates the same rotating direction of the motor while the rotating direction of others are opposite.
- 转速是以电动机的同步转速 (50Hz : 1500r/min、60Hz : 1800r/min) 为基准除以减速比而算出来的数值。实际转速将随负载大小变化所示数值减少2%~20%左右。
The speed is calculated by dividing the motor's synchronous speed (50Hz : 1500r/min、60Hz : 1800r/min) by the gear ratio. The actual speed is 2%~20% less than the displayed value, depending on the size of the load.
- 希望以大于下表的减速比进行进一步减速时，可在电动机与减速机之间安装减速比为10的中间减速机。这时的容许转矩为6N·m。
To reduce the speed beyond the gear ratio in the table, attach a decimal gearhead(gear ratio:10)between the gearhead and motor. In that case, the permissible torque is 6 N·m.

■ 容许力矩单位 Allowance Torque Unit : 上段 Upside (N.m) /下段 Belowside (kgf.cm)

类型 Type 电动机/减速机 Motor/Gearhead	减速比 Gear Ratio		3	3.6	5	6	7.5	9	12.5	15	18	25	30	36	50	60	75	90	100	120	150	180	200	
	转速 Speed r/min	50Hz	500	417	300	250	200	166	120	100	83	60	50	41	30	25	20	16	15	12.5	10	8.3	7.5	
		60Hz	600	500	360	300	240	200	144	120	100	72	60	50	36	30	24	20	18	15	12	10	9	
4RK25GN-AM 4RK25GN-EM 4RK25GN-CM 4RK25GN-HM 4RK25GN-SM	4GN□K	50Hz	0.49	0.58	0.81	0.97	1.2	1.5	2.0	2.4	2.9	3.7	4.4	5.3	6.6	7.9	8	8	8	8	8	8	8	
		5.00	5.91	8.26	9.89	12.2	15.3	20.4	24.4	29.6	37.7	44.9	54.1	67.3	80	80	80	80	80	80	80	80	80	
		60Hz	0.40	0.48	0.67	0.80	1.0	1.2	1.7	2.0	2.4	3.0	3.6	4.3	5.4	6.5	8	8	8	8	8	8	8	8
		4.08	4.89	6.83	8.16	10.2	12.2	17.3	20.4	24.4	30.6	36.7	43.8	55.1	66.3	80	80	80	80	80	80	80	80	80

■ 容许悬挂负载 · 容许轴向负载 To Allow The Hoisting Of The Load Allow Axial Load

电动机 (圆轴型) → 272页 Motor(Round Shaft) → P272
减速机 → 272页 Gearhead → P272

■ 减速机的容许负载惯性惯量 J Permissible Load Inertia J For Gearhead

→ 272页 → P272

■ 起动、制动特性 (参考值) Starting And Brake Characteristics(Reference Values)

- 单相电动机 Single-phase Motor
- 三相电动机 Three-phase Motor

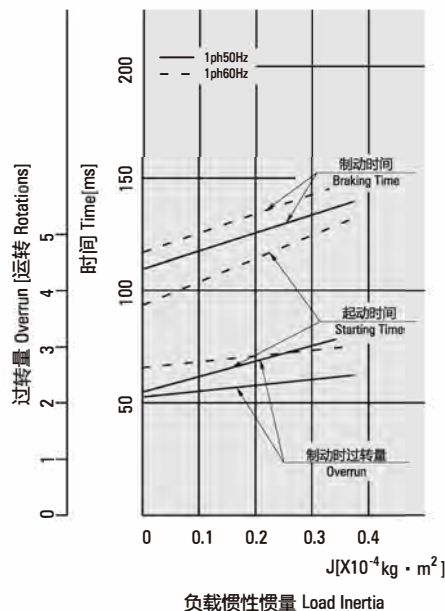
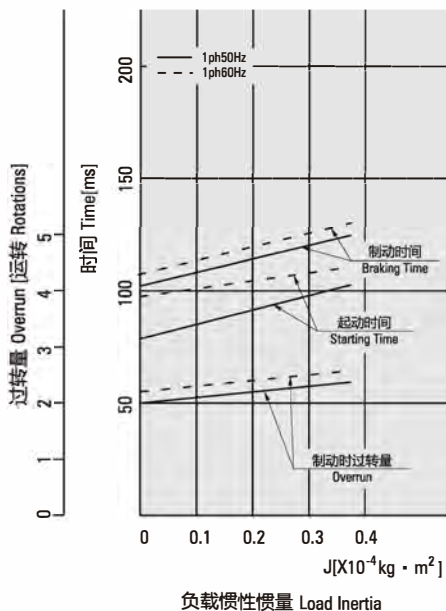

外形图 (单位 mm) Dimensions(Unit mm)

减速器附有安装用螺丝 Mounting screws are included with gearhead.

导线型 Lead Wiring Type

重量 Weight : 电动机 Motor : 2.15kg

减速器 Gearhead : 0.8kg

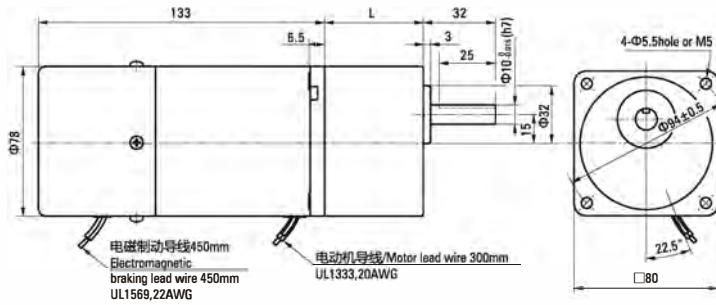

电动机型号 Motor Model	减速器型号 Gearhead Model	减速比 Gear Ratio	L1
4RK25GN-AM	4GN□K	3~18	32
4RK25GN-EM			
4RK25GN-CM		25~200	43.5
4RK25GN-HM			
4RK25GN-SM			

减速器型号的□中为减速比的数值

Enter the gear ratio in the box (□) within the model name

键·键槽 (减速器附件) Key·Keyway(Accessory Of Gearhead)

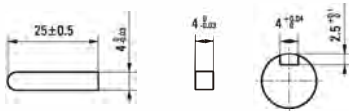

圆轴型的转轴部分 Shaft Section Of Round Shaft Type

除重量及轴部外电动机外形与齿轮轴型相同。

Excluding weight and the shaft section motor shape are the same as those of the pinion shaft type.

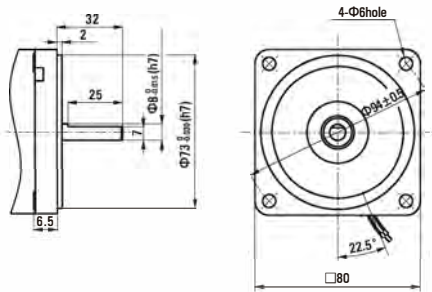

中间减速器 Decimal Gearhead

可安装在GN齿轮轴型上 Can be connected to GN pinion shaft type

电动机外形与齿轮轴型相同

4GN10XK

重量 Weight : 0.41kg

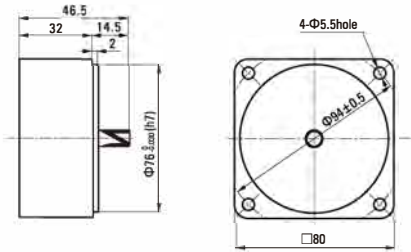

电容器外形尺寸 Formal Dimension Of Capacitor

型号 Model		电容器型号 Capacitor Model	L	W	H
齿轮轴型 Pinion Shaft	圆轴型 Round Shaft				
4RK25GN-AM	4RK25A-AM	ZD100CFAUL	58	26	38
4RK25GN-EM	4RK25A-EM	ZD80CFAUL	48	26.5	38
4RK25GN-CM	4RK25A-CM	ZD18BFAUL	37	15	27

常规电容器出线为引线,也可根据客户要求配置插片式187#

Note: Conventional capacitor is a lead wire type. Inserted 187# is optional

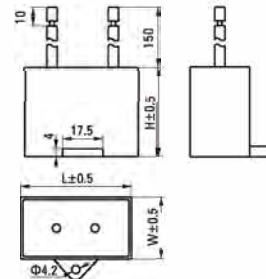

弧锥直角 SPIRAL BEVEL RIGHT ANGLE

■ 装有减速器时的容许转矩 Gear Motor-Torque Table

- 减速器·中间减速器另售。● 电动机型号的□中为表示带端子箱型的记号(T)。
Gearhead and mid-gearbox can be sold separately. Enter the code that represents the terminal box type (T) in the box (□) within the model name.
- 减速器型号的□中为减速比的数值。□色表示与电动机同一方向运转，其他则为相反方向。
Enter the gear ratio in the box (□) within the model name.
The colored background □ indicates the same rotating direction of the motor while the rotating direction of others are opposite.
- 转速是以电动机的同步转速 (50Hz:1500r/min、60Hz:1800r/min) 为基准除以减速比而算出来的数值。实际转速将随负载大小变化而比所示数值减少2%~20%左右。
The speed is calculated by dividing the motor's synchronous speed (50Hz:1500r/min、60Hz:1800r/min) by the gear ratio. The actual speed is 2%~20% less than the displayed value, depending on the size of the load.
- 希望以大于下表的减速比进行进一步减速时，可在电动机与减速器之间安装减速比为10的中间减速器。这时的容许转矩为8N·m。
To reduce the speed beyond the gear ratio in the table, attach a mid-gearbox (gear ratio:10) between the gearhead and motor. In that case, the permissible torque is 8N·m.

■ 容许力矩单位 Allowance Torque Unit: 上段 Upside (N.m) / 下段 Belowside (kgf.cm)

机型Type 电动机/减速器 Motor/Gearhead	减速比Gear Ratio	容许力矩 Allowance Torque																					
		3	3.6	5	6	7.5	9	12.5	15	18	25	30	3.6	50	60	75	90	100	120	150	180		
电动机/减速器 Motor/Gearhead	转速Speed r/min	50Hz	500	417	300	250	200	166	120	100	83	60	50	417	30	25	20	16	15	12	10	8	
	60Hz	600	500	360	300	240	200	144	120	100	72	60	500	36	30	24	20	18	15	12	10		
4RK25GN-AM□ 4RK25GN-EM□ 4RK25GN-CM□ 4RK25GN-HM□ 4RK25GN-SM□	容许力矩 Allowance Torque	50Hz	4GN□RC	0.36	0.43	0.59	0.71	0.99	1.16	1.64	1.97	2.37	3.29	3.95	4.73	6.58	7.10	8.00	8.00	8.00	8.00	8.00	
			4GN□RT	3.62	4.35	6.04	7.25	10.1	12.1	16.8	20.1	24.2	33.5	40.3	48.3	67.1	72.5	80.0	80.00	80.00	80.00	80.00	80.00
		60Hz	4GN□RC	0.29	0.34	0.48	0.57	0.80	0.95	1.33	1.59	1.91	2.65	3.18	3.82	5.30	5.73	7.16	8.00	8.00	8.00	8.00	8.00
			4GN□RT	2.92	3.51	4.87	5.84	8.12	9.74	13.5	16.2	19.5	27.1	32.5	39.0	54.1	58.4	73.0	80.00	80.00	80.00	80.00	80.00

■ 刹车尺寸图 Brake Type Drawing

4RK25GN-AM□/4GN□RC 4RK25GN-EM□/4GN□RC	4RK25GN-CM□/4GN□RC 4RK25GN-HM□/4GN□RC	4RK25GN-SM□/4GN□RC	4RK25GN-AM□/4GN□RT 4RK25GN-EM□/4GN□RT	4RK25GN-CM□/4GN□RT 4RK25GN-HM□/4GN□RT	4RK25GN-SM□/4GN□RT
--	--	--------------------	--	--	--------------------

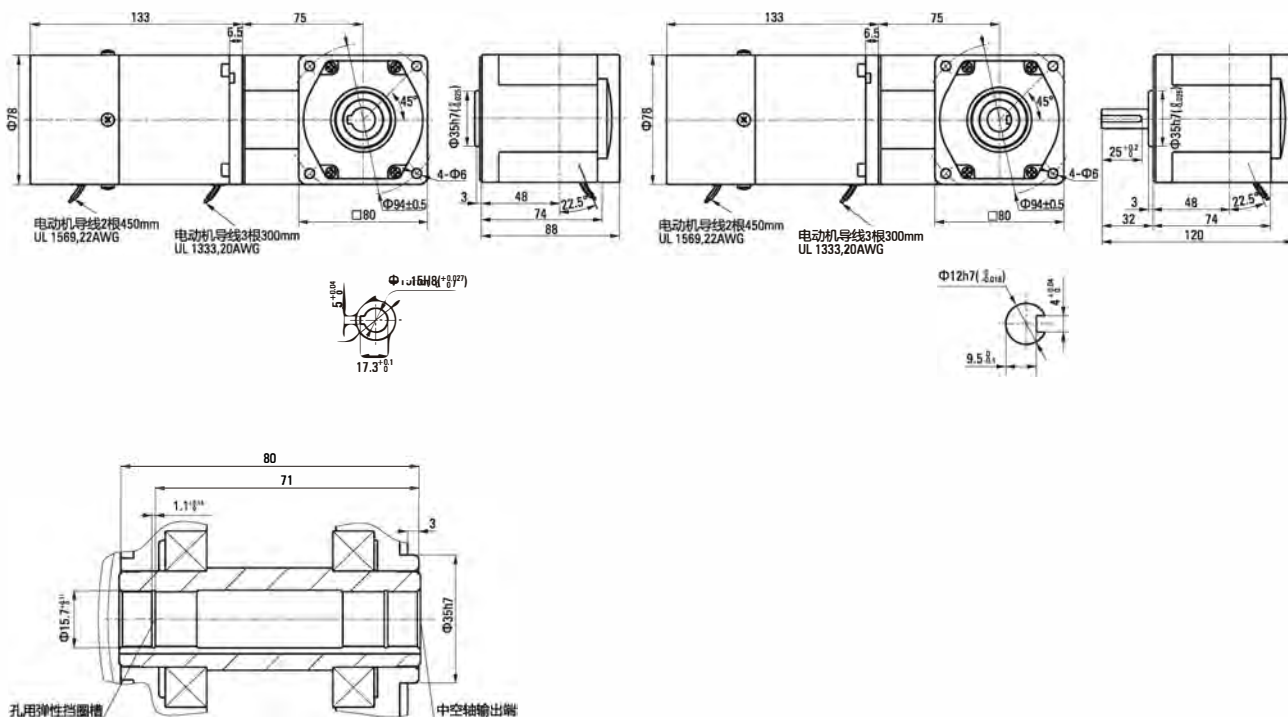

蜗轮蜗杆直角 WORM GEAR RIGHT ANGLE

■ 装有减速器时的容许转矩 Gear Motor-Torque Table

- 减速器·中间减速器另售。● 电动机型号的□中为表示带端子箱型的记号(T)。
Gearhead and mid-gearbox can be sold separately. Enter the code that represents the terminal box type (T) in the box (□) within the model name.
- 减速器型号的□中为减速比的数值。□色表示与电动机同一方向运转，其他则为相反方向。
Enter the gear ratio in the box (□) within the model name.
The colored background □ indicates the same rotating direction of the motor while the rotating direction of others are opposite.
- 转速是以电动机的同步转速 (50Hz:1500r/min、60Hz:1800r/min) 为基准除以减速比而算出来的数值。实际转速将随负载大小变化而比所示数值减少2%~20%左右。
The speed is calculated by dividing the motor's synchronous speed (50Hz:1500r/min、60Hz:1800r/min) by the gear ratio. The actual speed is 2%~20% less than the displayed value, depending on the size of the load.
- 希望以大于下表的减速比进行进一步减速时，可在电动机与减速器之间安装减速比为10的中间减速器。这时的容许转矩为8N·m。
To reduce the speed beyond the gear ratio in the table, attach a mid-gearbox (gear ratio:10) between the gearhead and motor. In that case, the permissible torque is 8N·m.

■ 容许力矩单位 Allowance Torque Unit: 上段 Upside (N.m) / 下段 Belowside (kgf.cm)

机型Type	减速比Gear Ratio	3	3.6	5	6	7.5	9	12.5	15	18	25	30	3.6	50	60	75	90	100	120	150	180	
电动机/减速器 Motor/Gearhead	转速Speed r/min	50Hz	500	417	300	250	200	166	120	100	83	60	50	417	30	25	20	16	15	12	10	8
	60Hz	600	500	360	300	240	200	144	120	100	72	60	500	36	30	24	20	18	15	12	10	
4RK25GN-AM□ 4RK25GN-EM□ 4RK25GN-CM□/4GN□RH 4RK25GN-HM□/4GN□RA 4RK25GN-SM□	容许力矩 Allowance Torque	50Hz	0.26	0.31	0.39	0.46	0.58	0.70	0.97	1.16	1.39	1.93	2.32	2.78	3.87	4.64	5.80	6.96	7.74	8.00	8.00	8.00
			2.63	3.16	3.95	4.74	5.92	7.10	9.87	11.8	14.2	19.7	23.7	28.4	39.5	47.4	59.2	71.0	78.9	80.0	80.0	80.0
		60Hz	0.21	0.31	0.39	0.46	0.58	0.70	0.97	1.16	1.39	1.93	2.32	2.78	3.87	4.64	5.82	6.96	7.74	8.00	8.00	8.00
			2.12	3.16	3.95	4.74	5.92	7.10	9.87	11.8	14.2	19.7	23.7	28.4	39.5	47.4	59.2	71.0	78.9	80.0	80.0	80.0

■ 刹车尺寸图 Brake Type Drawing

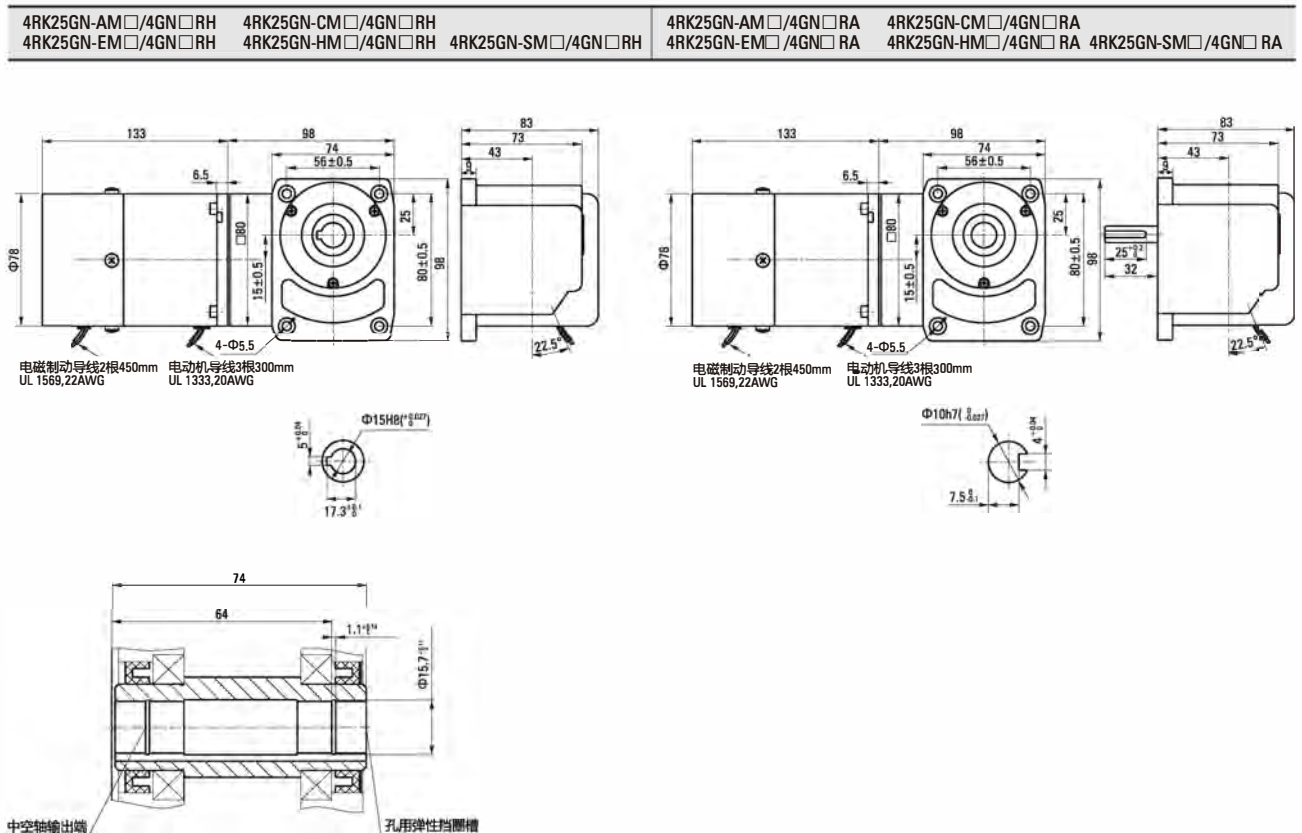

连接图 Wiring Diagram

- 运转方向指从电动机轴看来的方向。CW表示顺时针方向，CCW表示逆时针方向。

The direction of motor rotation is as viewed from the shaft end of motor. CW represents the clockwise direction, while CCW represents the counterclockwise direction.

- 表中所记品名为齿轮轴型，圆轴型亦同。Name indicated in the list is pinion shaft type, also valid for the equivalent round shaft type.

单相电动机 Single-phase Motor	
4RK25GN-AM、4RK25GN-EM、4RK25GN-CM、4RK25GN-HM	

SW1为电动机的运行/停止及电磁制动操作作用开关。(联动)

SW1 operates both motor and electromagnetic brake action. (Switched Simultaneously)

SW1设定于ON时，电磁制动解除，电动机开始运行。

The motor will rotate when SW1 is switched simultaneously to ON.

SW1设定于OFF时，电动机停止，电磁制动开始工作。

When SW1 is switched simultaneously to OFF, the motor stops immediately with the electromagnetic brake and holds the load.

在电动机停止状态下解除电磁制动时，应将SW1设定为非联动，而仅将黑色导线侧的触点设定为ON。

If you wish to release the brake while the motor is stopped, set the SW1 to off and connection point at the side of black lead to on.

运转方向。Direction of Rotation.

将SW2转换至CW侧时，电动机作顺时针方向运转。

To rotate the motor in a clockwise (CW) direction, turn SW2 to CW.

将SW2转换至CCW侧时，电动机作逆时针方向运转。

To rotate the motor in a counterclockwise (CCW) direction, turn SW2 to CCW.

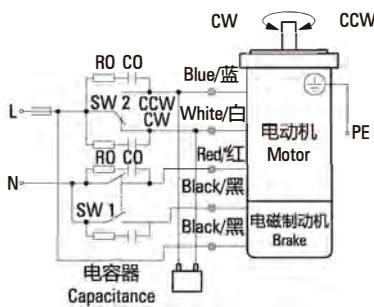

开关 号码 Switch No.	开关的触点容量Capacitor of Switch Connection Point		参考 Note
	单相100V、 110/120V输入 Single-Phase 100 VAC, 110/120 VAC Input	单相220V、 230V输入 Single-Phase 200 VAC, 220/230 VAC Input	
SW1	AC125V 3A以上 (感应负载) 125 VAC 3A minimum (Inductive Load)	AC250V 1.5A以上 (感应负载) 250 VAC 1.5A A minimum (Inductive Load)	联动Switched Simultaneously
SW2			

三相电动机 Three-phase Motor	
3RK15GN-SM	

SW1为电动机的运行/停止及电磁制动操作作用开关。(联动)

SW1 operates both motor and electromagnetic brake action. (Switched Simultaneously)

SW1设定于ON时，电磁制动解除，电动机开始运行。

The motor will rotate when SW1 is switched simultaneously to ON.

SW1设定于OFF时，电动机停止，电磁制动开始工作。

When SW1 is switched simultaneously to OFF, the motor stops immediately with the electromagnetic brake and holds the load.

在电动机停止状态下解除电磁制动时，应将SW1设定为非联动，而仅将黑色导线侧的触点设定为ON。

If you wish to release the brake while the motor is stopped, set the SW1 to off and connection point at the side of black lead to on.

运转方向。Direction of Rotation.

若对换R、S、T中任意二条，电动机逆时针方向运转。

To change the rotation direction, change any two connections between R, S and T.

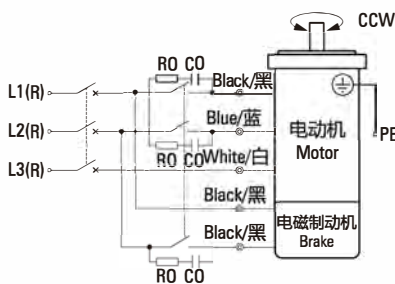

开关 号码 Switch No.	开关的触点容量Capacitor of Switch Connection Point	参考 Note
SW1	AC250V 1.5A以上 (感应负载) 250 VAC 1.5 A minimum (Inductive Load)	联动 Switched Simultaneously

请注意Notes:

- RO/CO为吸收电涌电压用CR电路。[RO=5~200Ω、CO=0.1~0.2μF、200WV (400WV)] 请使用选购配件EPCR1201-2。

- RO and CO indicate surge suppressor circuit. [RO=5~200Ω, CO=0.1~0.2 μF, 200 WV (400 WV)] EPCR1201-2 is available as an optional surge suppressor.

无励磁动作型电磁制动电动机

POWER OFF ACTIVATED TYPE ELECTROMAGNETIC BRAKE MOTOR

■ 40W □ 90mm



规格 Specs / 电动机 Motor

- 没有内藏简易制动 This type of motor does not contain a built-in simple brake mechanism.

型号 Model · 类型 Type 导线型 Lead Wire Type		额定 Rating	输出功率 Output power	电压 Voltage	频率 Frequency	电流 Current	启动转矩 Starting Torque	额定转矩 Rated Torque	额定转速 Rated Speed	电容器容量 Capacitor
齿轮轴型 Pinion Shaft	圆轴型 Round Shaft									
5RK40GN-AM	5RK40A-AM	30min	40	1ph 100	50	0.78	300	315	1250	15.0
					60	1.05		260	1550	
5RK40GN-EM	5RK40A-EM	30min	40	1ph 110	60	0.79	260	260	1550	12.0
				1ph 120		0.80				
5RK40GN-CM	5RK40A-CM	30min	40	1ph 220	50	0.45	270	315	1250	3.0
				1ph 230						
5RK40GN-HM	5RK40A-HM	30min	40	1ph 220	60	0.45	270	260	1550	3.0
				1ph 230						
5RK40GN-SM	5RK40A-SM	30min	40	3ph 220	50	0.30	800	315	1250	0.30
					60	0.25	660	250	1600	0.25

- 各种安全规格以电动机铭牌上的型号取得认定。

When the motor is approved under various safety standards, the model name on the nameplate is the approved model name.

- (P): 内藏热保护装置 (自动复位型)。在电动机因某种原因过热时会自行起动作使电动机停止。

Contains a built-in thermal protector(automatic return). If a motor overheats for any reason, the thermal protector is opened and the motor stops.

- 电动机温度下降后会自行恢复运行，故在进行检查作业时请务必事先切断电源。

When the motor temperature drops, the thermal protector closes and the motor restarts. Be sure to turn the motor off before inspecting.

- 注：“-A”型号中电压为110V时，配置电容器容量以实际铭牌为准。

Note:“-A” it means the voltage 110V,the assembly capacitor vaule it is according the labe.

种类 Type

- 电动机 Motor

机型 Type	型号 Model	
	齿轮轴型 Pinion Shaft	圆轴型 Round Shaft
导线型 Lead Wire Type	5RK40GN-AM	5RK40A-AM
	5RK40GN-EM	5RK40A-EM
	5RK40GN-CM	5RK40A-CM
	5RK40GN-HM	5RK40A-HM
	5RK40GN-SM	5RK40A-SM

- 平行轴减速器 (另售) Parallel Shaft Gearhead (Sold Separately)

减速器种类 Gearhead Type	减速器型号 Gearhead Model	减速比 Gear Ratio
长寿命●低噪音 Long Life ● Low Noise	5GN□K	3、3.6、5、6、7.5、9、 12.5、15、18、25、30、 36、50、60、75、90、 100、120、150、180、200
	5GN10XK (中间减速器 Decimal Gearhead)	

- 减速器型号的□中为减速比的数值

Enter the gear ratio in the box (□) within the model name

■ 装有减速器时的容许转矩 Gear Motor-Torque Table

- 减速器另售·中间减速器另售。电动机型号的□中为表示带端子箱型的记号(T)。
Gearhead and mid-gearbox can be sold separately. Enter the code that represents the terminal box type (T) in the box (□) within the model name.
- 减速品型号的□中为减速比的数值。
Enter the gear ratio in the box(□) within the model name.
- □色表示与电动机同一方向运转，其他则为相反方向。
The colored background □ indicates the same rotating direction of the motor while the rotating direction of others are opposite.
- 转速是以电动机的同步转速 (50Hz : 1500r/min、60Hz : 1800r/min) 为基准除以减速比而算出来的数值。实际转速将随负载大小变化所示数值减少2%~20%左右。
The speed is calculated by dividing the motor's synchronous speed (50Hz : 1500r/min、60Hz : 1800r/min) by the gear ratio. The actual speed is 2%~20% less than the displayed value, depending on the size of the load.
- 希望以大于下表的减速比进行进一步减速时，可在电动机与减速机之间安装减速比为10的中间减速机。这时的容许转矩为6N·m。
To reduce the speed beyond the gear ratio in the table, attach a decimal gearhead(gear ratio:10)between the gearhead and motor. In that case, the permissible torque is 6 N·m.

■ 容许力矩单位 Allowance Torque Unit : 上段 Upside (N.m) /下段 Belowside (kgf.cm)

类型 Type 电动机/减速机 Motor/Gearhead	减速比 Gear Ratio		3	3.6	5	6	7.5	9	12.5	15	18	25	30	36	50	60	75	90	100	120	150	180	200	
	转速 Speed r/min	50Hz	500	417	300	250	200	166	120	100	83	60	50	41	30	25	20	16	15	12.5	10	8.3	7.5	
		60Hz	600	500	360	300	240	200	144	120	100	72	60	50	36	30	24	20	18	15	12	10	9	
5RK40GN-AM 5RK40GN-EM 5RK40GN-CM 5RK40GN-HM 5RK40GN-SM	5GN□K	50Hz	0.77	0.92	1.3	1.5	1.9	2.3	3.2	3.8	4.6	5.7	6.9	8.3	10	10	10	10	10	10	10	10	10	
			7.85	9.38	13.2	15.3	19.4	23.4	32.6	38.7	46.9	58.1	70.4	84.7	100	100	100	100	100	100	100	100	100	
		60Hz	0.63	0.76	1.1	1.3	1.6	1.9	2.6	3.2	3.8	4.7	5.7	6.8	8.6	10	10	10	10	10	10	10	10	10
			6.42	7.75	11.2	13.2	16.3	19.3	16.5	32.6	38.7	47.9	58.1	69.3	87.7	100	100	100	100	100	100	100	100	100

■ 容许悬挂负载 · 容许轴向负载 To Allow The Hoisting Of The Load Allow Axial Load

电动机 (圆轴型) → 272页 Motor(Round Shaft) → P272
减速机 → 272页 Gearhead → P272

■ 减速机的容许负载惯性量 J Permissible Load Inertia J For Gearhead

→ 272页 → P272

■ 起动、制动特性 (参考值) Starting And Brake Characteristics(Reference Values)

- 单相电动机 Single-phase Motor
- 三相电动机 Three-phase Motor

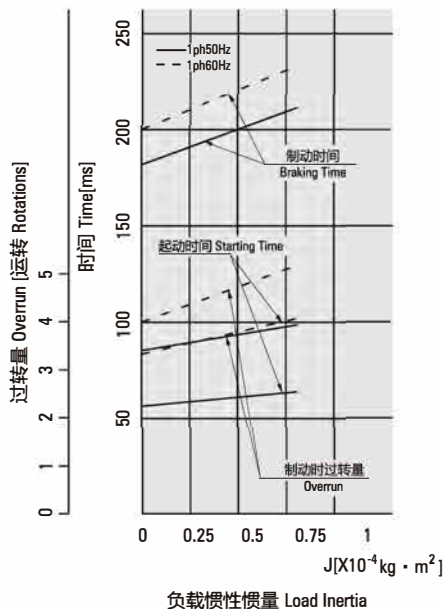
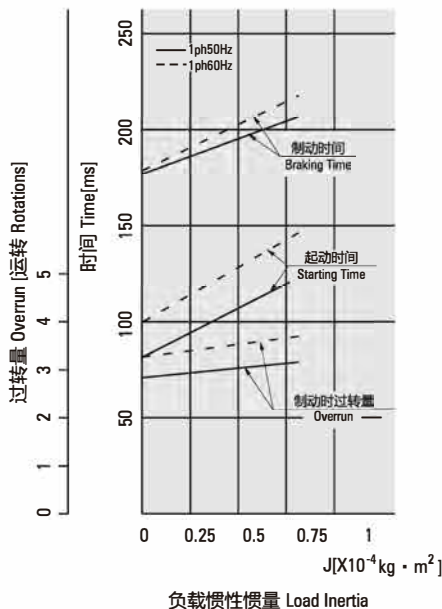

外形图 (单位 mm) Dimensions(Unit mm)

减速器附有安装用螺丝 Mounting screws are included with gearhead.

● 导线型 Lead Wiring Type

重量 Weight : 电动机 Motor : 3.1kg 减速器 Gearhead : 1.35kg

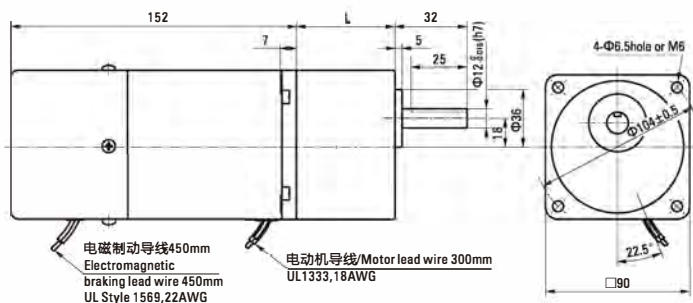

电动机型号 Motor Model	减速器型号 Gearhead Model	减速比 Gear Ratio	L1
5RK40GN-AM	5GN□K	3~18	42
5RK40GN-EM			
5RK40GN-CM		25~200	60
5RK40GN-HM			
5RK40GN-SM			

● 减速器型号的□中为减速比的数值
Enter the gear ratio in the box (□) within the model name

● 键·键槽 (减速器附件) Key·Keyway(Accessory Of Gearhead)

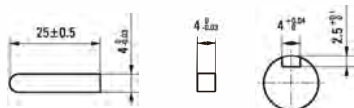

● 圆轴型的转轴部分 Shaft Section Of Round Shaft Type

除重量及轴部外电动机外形与齿轮轴型相同。
Excluding weight and the shaft section motor shape are the same as those of the pinion shaft type.

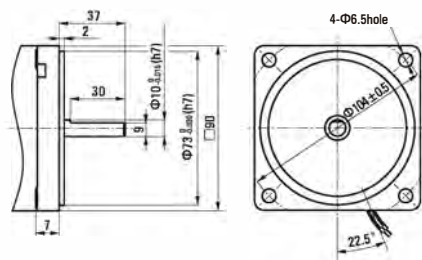

● 中间减速器 Decimal Gearhead

可安装在GN齿轮轴型上 Can be connected to GN pinion shaft type
电动机外形与齿轮轴型相同

5GN10XK
重量 Weight : 0.6kg

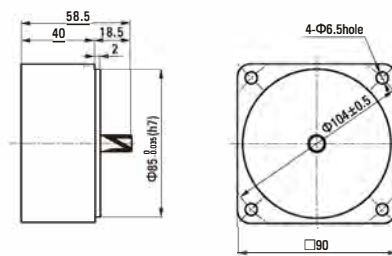

电容器外形尺寸 Formal Dimension Of Capacitor

型号 Model		电容器型号 Capacitor Model	L	W	H
齿轮轴型 Pinion Shaft	圆轴型 Round Shaft				
5RK40GN-AM	5RK40A-AM	ZD150CFAUL	47	20	31
5RK40GN-EM	5RK40A-EM	ZD120CFAUL	58	30	40
5RK40GN-CM	5RK40A-CM	ZD30BFAUL	38	18.5	29

● 常规电容器出线为引线,也可根据客户要求配置插片式187#

Note: Conventional capacitor is a lead wire type. Inserted 187# is optional

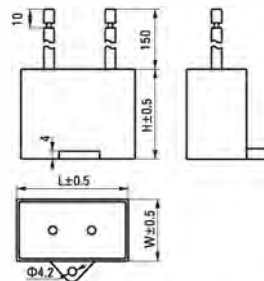

弧锥直角 SPIRAL BEVEL RIGHT ANGLE

■ 装有减速器时的容许转矩 Gear Motor-Torque Table

- 减速器 中间减速器另售。● 电动机型号的□中为表示带端子箱型的记号(T)。
Gearhead and mid-gearbox can be sold separately. Enter the code that represents the terminal box type (T) in the box (□) within the model name.
- 减速器型号的□中为减速比的数值。□色表示与电动机同一方向运转，其他则为相反方向。
Enter the gear ratio in the box (□) within the model name.
The colored background □ indicates the same rotating direction of the motor while the rotating direction of others are opposite.
- 转速是以电动机的同步转速 (50Hz:1500r/min、60Hz:1800r/min) 为基准除以减速比而算出来的数值。实际转速将随负载大小变化而比所示数值减少2%~20%左右。
The speed is calculated by dividing the motor's synchronous speed (50Hz:1500r/min、60Hz:1800r/min) by the gear ratio. The actual speed is 2%~20% less than the displayed value, depending on the size of the load.
- 希望以大于下表的减速比进行进一步减速时，可在电动机与减速器之间安装减速比为10的中间减速器。这时的容许转矩为20N·m。
To reduce the speed beyond the gear ratio in the table, attach a mid-gearbox (gear ratio:10) between the gearhead and motor. In that case, the permissible torque is 20N·m.

■ 容许力矩单位 Allowance Torque Unit: 上段 Upside (N.m) / 下段 Belowside (kgf.cm)

机型Type 电动机/减速器 Motor/Gearhead	减速比Gear Ratio	容许力矩 Allowance Torque																				
		3	3.6	5	6	7.5	9	12.5	15	18	25	30	3.6	50	60	75	90	100	120	150	180	
5RK40GU-AM□ 5RK40GU-EM□ 5RK40GU-CM□ 5RK40GU-HM□ 5RK40GU-SM□	5GU□RC 5GU□RT	50Hz	500	417	300	250	200	166	120	100	83	60	50	417	30	25	20	16	15	12	10	8
		60Hz	600	500	360	300	240	200	144	120	100	72	60	500	36	30	24	20	18	15	12	10
5RK40GU-AM□ 5RK40GU-EM□ 5RK40GU-CM□ 5RK40GU-HM□ 5RK40GU-SM□	5GU□RC 5GU□RT	50Hz	0.57	0.68	0.59	1.14	1.58	1.89	2.63	3.16	3.79	5.26	6.31	6.8	9.5	11.4	14.2	17.0	18.9	20.0	20.0	20.0
		60Hz	0.46	0.55	0.76	0.92	1.27	1.53	2.12	2.55	3.05	4.24	5.09	5.50	7.64	9.16	11.5	13.7	15.3	18.3	20.0	20.0
5RK40GU-AM□ 5RK40GU-EM□ 5RK40GU-CM□ 5RK40GU-HM□ 5RK40GU-SM□	5GU□RC 5GU□RT	50Hz	5.80	6.96	9.66	11.6	16.1	19.3	26.8	32.2	38.6	53.7	64.4	70	97	116	145	174	193	200	200	200
		60Hz	4.67	5.61	7.79	9.35	13.0	15.6	21.6	26.0	31.2	43.3	51.9	56.1	77.9	93.5	117	140	156	187	200	200

■ 刹车尺寸图 Brake Type Drawing

5RK40GU-AM□/5GU□RC	5RK40GU-CM□/5GU□RC	5RK40GU-SM□/5GU□RC	5RK40GU-AM□/5GU□RT	5RK40GU-CM□/5GU□RT	5RK40GU-SM□/5GU□RT
5RK40GU-EM□/5GU□RC	5RK40GU-HM□/5GU□RC		5RK40GU-EM□/5GU□RT	5RK40GU-HM□/5GU□RT	

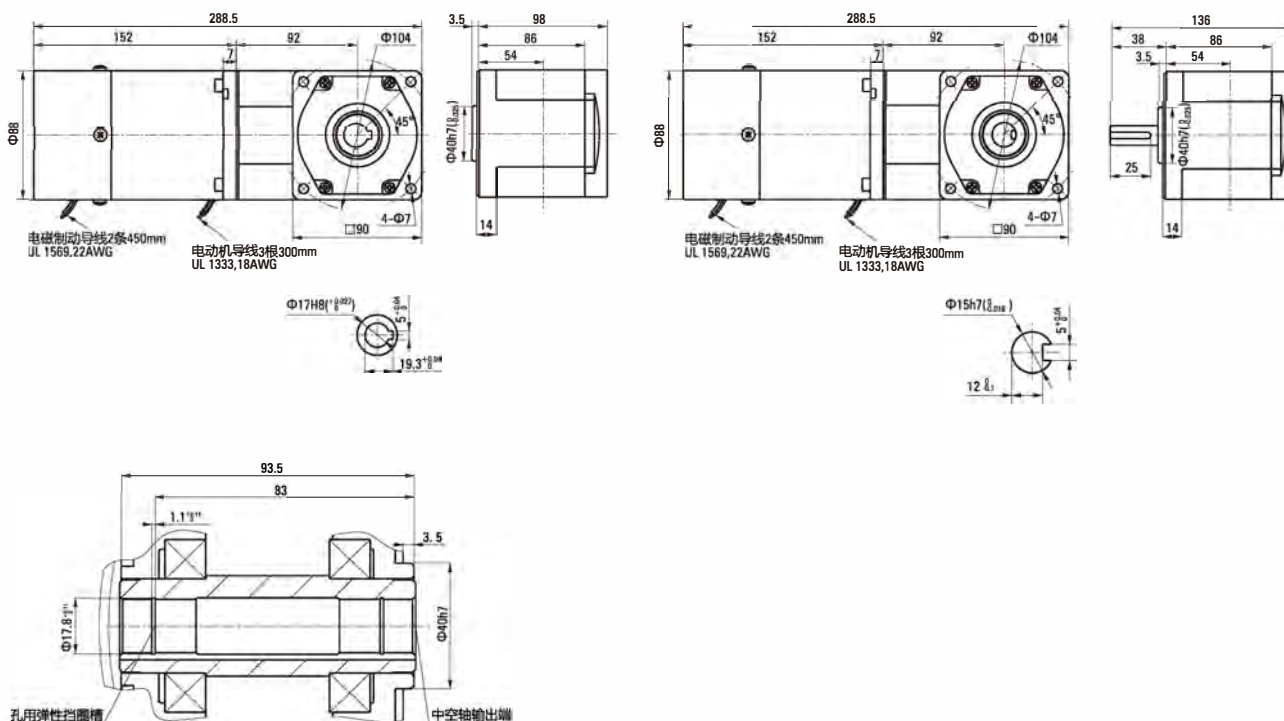

蜗轮蜗杆直角 WORM GEAR RIGHT ANGLE

■ 装有减速器时的容许转矩 Gear Motor-Torque Table

- 减速器-中间减速器另售。● 电动机型号的□中表示带端子箱型的记号(T)。
Gearhead and mid-gearbox can be sold separately. Enter the code that represents the terminal box type (T) in the box (□) within the model name.
- 减速器型号的□中为减速比的数值。□色表示与电动机同一方向运转，其他则为相反方向。
Enter the gear ratio in the box (□) within the model name.
The colored background □ indicates the same rotating direction of the motor while the rotating direction of others are opposite.
- 转速是以电动机的同步转速 (50Hz:1500r/min、60Hz:1800r/min) 为基准除以减速比而算出来的数值。实际转速将随负载大小变化而比所示数值减少2%~20%左右。
The speed is calculated by dividing the motor's synchronous speed (50Hz:1500r/min、60Hz:1800r/min) by the gear ratio. The actual speed is 2%~20% less than the displayed value, depending on the size of the load.
- 希望以大于下表的减速比进行进一步减速时，可在电动机与减速器之间安装减速比为10的中间减速器。这时的容许转矩为20N·m。
To reduce the speed beyond the gear ratio in the table, attach a mid-gearbox (gear ratio:10) between the gearhead and motor. In that case, the permissible torque is 20N·m.

■ 容许力矩单位 Allowance Torque Unit: 上段 Upside (N.m) / 下段 Belowside (kgf.cm)

机型Type 电动机/减速器 Motor/Gearhead	减速比Gear Ratio	3	3.6	5	6	7.5	9	12.5	15	18	25	30	3.6	50	60	75	90	100	120	150	180		
电动机/减速器 Motor/Gearhead	转速Speed r/min	50Hz	500	417	300	250	200	166	120	100	83	60	50	417	30	25	20	16	15	12	10	8	
	60Hz	600	500	360	300	240	200	144	120	100	72	60	500	36	30	24	20	18	15	12	10		
5RK40GU-AM□ 5RK40GU-EM□ 5RK40GU-CM□ 5RK40GU-HM□ 5RK40GU-SM□	5GU□RH 5GU□RA	容许力矩 Allowance Torque	50Hz	0.41	0.50	0.62	0.74	0.93	1.11	1.55	1.86	2.23	3.09	3.71	4.46	6.19	7.43	9.28	11.1	12.4	14.9	18.6	20.0
			4.21	5.05	6.31	7.58	9.47	11.4	15.8	18.9	22.7	31.6	37.9	45.5	63.1	75.8	94.7	114	126	152	189	200	
			60Hz	0.33	0.40	0.50	0.60	0.75	0.90	1.25	1.50	1.80	2.50	2.99	3.59	4.99	5.99	7.49	8.98	9.98	12.0	15.0	18.0
			3.39	4.07	5.09	6.11	7.64	9.17	12.7	15.3	18.3	25.5	30.6	36.7	50.9	61.1	76.4	91.7	102	122	153	183	

■ 刹车尺寸图 Brake Type Drawing

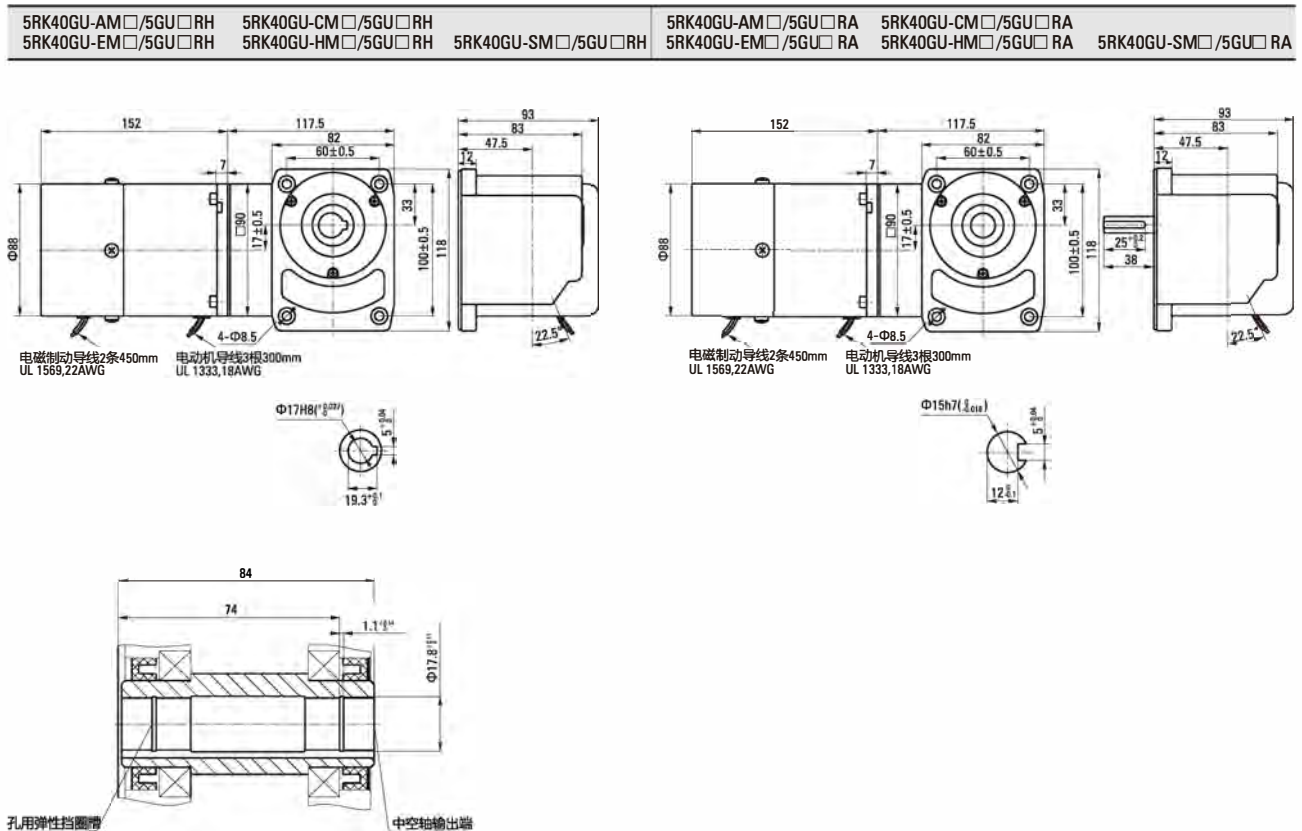

连接图 Wiring Diagram

●运转方向指从电动机轴看来的方向。CW表示顺时针方向，CCW表示逆时针方向。

The direction of motor rotation is as viewed from the shaft end of motor. CW represents the clockwise direction, while CCW represents the counterclockwise direction.

●表中所记品名为齿轮轴型，圆轴型亦同。Name indicated in the list is pinion shaft type, also valid for the equivalent round shaft type.

单相电动机 Single-phase Motor	
5RK40GN-AM、5RK40GN-EM、5RK40GN-CM、5RK40GN-HM	

SW1为电动机的运行/停止及电磁制动操作作用开关。(连动)

SW1 operates both motor and electromagnetic brake action. (Switched Simultaneously)

SW1设定于ON时，电磁制动解除，电动机开始运行。

The motor will rotate when SW1 is switched simultaneously to ON.

SW1设定于OFF时，电动机停止，电磁制动开始工作。

When SW1 is switched simultaneously to OFF, the motor stops immediately with the electromagnetic brake and holds the load.

在电动机停止状态下解除电磁制动时，应将SW1设定为非连动，而仅将黑色导线侧的触点设定为ON。

If you wish to release the brake while the motor is stopped, set the SW1 to off and connection point at the side of black lead to on.

运转方向。Direction of Rotation.

将SW2转换至CW侧时，电动机作顺时针方向运转。

To rotate the motor in a clockwise (CW) direction, turn SW2 to CW.

将SW2转换至CCW侧时，电动机作逆时针方向运转。

To rotate the motor in a counterclockwise (CCW) direction, turn SW2 to CCW.

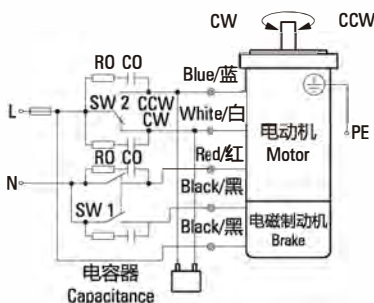

开关 号码 Switch No.	开关的触点容量Capacitor of Switch Connection Point		参考 Note
	单相100V、 110/120V输入 Single-Phase 100 VAC, 110/120 VAC Input	单相220V、 230V输入 Single-Phase 200 VAC, 220/230 VAC Input	
SW1	AC125V 3A以上 (感应负载) 125 VAC 3A minimum (Inductive Load)	AC250V 1.5A以上 (感应负载) 250 VAC 1.5A A minimum (Inductive Load)	连动Switched Simultaneously
SW2			

三相电动机 Three-phase Motor	
5RK40GN-SM	

SW1为电动机的运行/停止及电磁制动操作作用开关。(连动)

SW1 operates both motor and electromagnetic brake action. (Switched Simultaneously)

SW1设定于ON时，电磁制动解除，电动机开始运行。

The motor will rotate when SW1 is switched simultaneously to ON.

SW1设定于OFF时，电动机停止，电磁制动开始工作。

When SW1 is switched simultaneously to OFF, the motor stops immediately with the electromagnetic brake and holds the load.

在电动机停止状态下解除电磁制动时，应将SW1设定为非连动，而仅将黑色导线侧的触点设定为ON。

If you wish to release the brake while the motor is stopped, set the SW1 to off and connection point at the side of black lead to on.

运转方向。Direction of Rotation.

若对换R、S、T中任意二条，电动机逆时针方向运转。

To change the rotation direction, change any two connections between R, S and T.

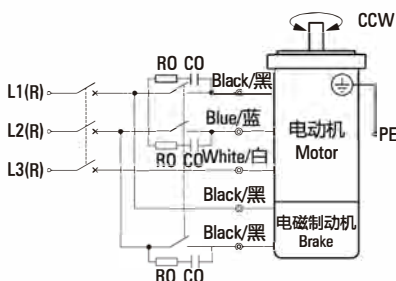

开关 号码 Switch No.	开关的触点容量Capacitor of Switch Connection Point	参考 Note
SW1	AC250V 1.5A以上 (感应负载) 250 VAC 1.5 A minimum (Inductive Load)	连动 Switched Simultaneously

请注意Notes:

●R0C0为吸收电涌电压用CR电路。[R0=5~200Ω、C0=0.1~0.2μF、200WV (400WV)] 请使用选购配件EPCR1201-2。

●R0 and C0 indicate surge suppressor circuit. [R0=5~200Ω, C0=0.1~0.2 μ F, 200 WV (400 WV)] EPCR1201-2 is available as an optional surge suppressor.

无励磁动作型电磁制动电动机

POWER OFF ACTIVATED TYPE ELECTROMAGNETIC BRAKE MOTOR

60W □90mm



规格 Specs / 电动机 Motor

- 没有内藏简易制动 This type of motor does not contain a built-in simple brake mechanism.

型号Model · 类型 Type 导线型 Lead Wire Type		额定 Rating	输出功率 Output power	电压 Voltage	频率 Frequency	电流 Current	启动转矩 Starting Torque	额定转矩 Rated Torque	额定转速 Rated Speed	电容器容量 Capacitor
齿轮轴型 Pinion Shaft	圆轴型 Round Shaft									
5RK60GN-AFM	5RK60A-AFM	30min	60	1ph 100	50	1.26	470	470	1250	25.0
					60	1.70		380	1550	
5RK60GN-EFM	5RK60A-EFM	30min	60	1ph 110 1ph 120	60	1.05	330	380	1550	15.0
							380			
5RK60GN-CFM	5RK60A-CFM	30min	60	1ph 220 1ph 230	50	0.55	420	470	1250	4.5
						0.60				
5RK60GN-HFM	5RK60A-HFM	30min	60	1ph 220 1ph 230	60	0.55	420	380	1550	
						0.60				
5RK60GN-SFM	5RK60A-SFM	30min	60	3ph 220	50	0.45	1000	470	1250	-
					60	0.40	800	380	1550	

- 各种安全规格以电动机铭牌上的型号取得认定。
When the motor is approved under various safety standards, the model name on the nameplate is the approved model name.
- (T): 内藏热保护装置 (自动复位型)。在电动机因某种原因过热时会自行起动作使电动机停止。
Contains a built-in thermal protector (automatic return). If a motor overheats for any reason, the thermal protector is opened and the motor stops.
- 电动机温度下降后会自行恢复运行，故在进行检查作业时请务必事先切断电源。
When the motor temperature drops, the thermal protector closes and the motor restarts. Be sure to turn the motor off before inspecting.
- 注：“-A”型号中电压为110V时，配置电容器容量以实际铭牌为准。
Note:“-A” it means the voltage 110v, the assembly capacitor vaule it is according the labe.

种类 Type

- 电动机 Motor

机型 Type	型号Model	
	齿轮轴型 Pinion Shaft	圆轴型 Round Shaft
导线型 Lead Wire Type	5RK60GN-AFM	5RK60A-AFM
	5RK60GN-EFM	5RK60A-EFM
	5RK60GN-CFM	5RK60A-CFM
	5RK60GN-HFM	5RK60A-HFM
	5RK60GN-SFM	5RK60A-SFM

- 平行轴减速器 (另售) Parallel Shaft Gearhead (Sold Separately)

减速器种类 Gearhead Type	减速器型号 Gearhead Model	减速比 Gear Ratio
长寿命●低噪音 Long Life ● Low Noise	5GN□K	3、3.6、5、6、7.5、9、 12.5、15、18、25、30、 36、50、60、75、90、 100、120、150、180、200
	5GN10XK (中间减速器 Decimal Gearhead)	

- 减速器型号的□中为减速比的数值
Enter the gear ratio in the box (□) within the model name

■ 装有减速器时的容许转矩 Gear Motor-Torque Table

- 减速器另售·中间减速器另售。
Gearhead and mid-gearbox can be sold separately.
- 减速品型号的□中为减速比的数值。
Enter the gear ratio in the box(□) within the model name.
- □色表示与电动机同一方向运转，其他则为相反方向。
The colored background □ indicates the same rotating direction of the motor while the rotating direction of others are opposite.
- 转速是以电动机的同步转速（50Hz：1500r/min、60Hz：1800r/min）为基准除以减速比而算出来的数值。实际转速将随负载大小变化所示数值减少2%~20%左右。
The speed is calculated by dividing the motor's synchronous speed (50Hz：1500r/min、60Hz：1800r/min) by the gear ratio. The actual speed is 2%~20% less than the displayed value, depending on the size of the load.
- 希望以大于下表的减速比进行进一步减速时，可在电动机与减速机之间安装减速比为10的中间减速机。这时的容许转矩为6N·m。
To reduce the speed beyond the gear ratio in the table, attach a decimal gearhead(gear ratio:10)between the gearhead and motor. In that case, the permissible torque is 6 N·m.

■ 容许力矩单位 Allowance Torque Unit：上段 Upside (N.m) /下段 Belowside (kgf.cm)

类型 Type 电动机/减速机 Motor/Gearhead	减速比 Gear Ratio		3	3.6	5	6	7.5	9	12.5	15	18	25	30	36	50	60	75	90	100	120	150	180	200
	转速 Speed r/min	50Hz	500	417	300	250	200	166	120	100	83	60	50	41	30	25	20	16	15	12.5	10	8.3	7.5
5RK60GN-AFM 5RK60GN-EFM 5RK60GN-CFM 5RK60GN-HFM 5RK60GN-SFM	5GN□K	60Hz	600	500	360	300	240	200	144	120	100	72	60	50	36	30	24	20	18	15	12	10	9
		50Hz	1.1	1.4	1.9	2.3	2.9	3.4	4.8	5.7	6.8	8.6	10	10	10	10	10	10	10	10	10	10	10
	5GN□K	50Hz	11.2	14.2	19.3	23.4	29.6	34.7	48.9	58.1	69.3	87.7	100	100	100	100	100	100	100	100	100	100	100
		60Hz	9.38	11.2	15.3	18.3	23.4	28.5	38.7	46.9	56.1	70.4	84.7	100	87.7	100	100	100	100	100	100	100	100

■ 容许悬挂负载 · 容许轴向负载 To Allow The Hoisting Of The Load Allow Axial Load

电动机 (圆轴型) → 272页 Motor(Round Shaft) → P272
 减速机 → 272页 Gearhead → P272

■ 减速机的容许负载惯性惯量 J Permissible Load Inertia J For Gearhead

→ 272页 → P272

■ 起动、制动特性 (参考值) Starting And Brake Characteristics(Reference Values)

- 单相电动机 Single-phase Motor
- 三相电动机 Three-phase Motor

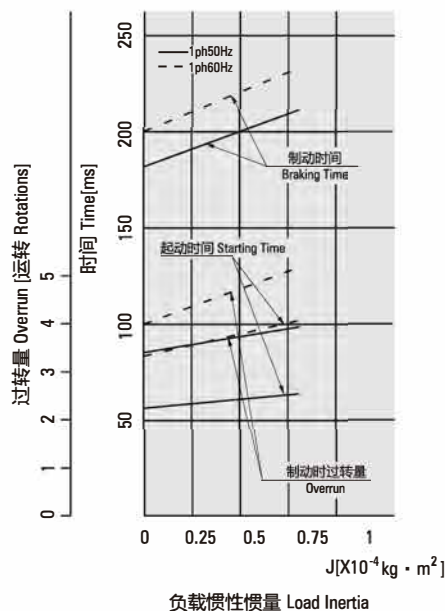
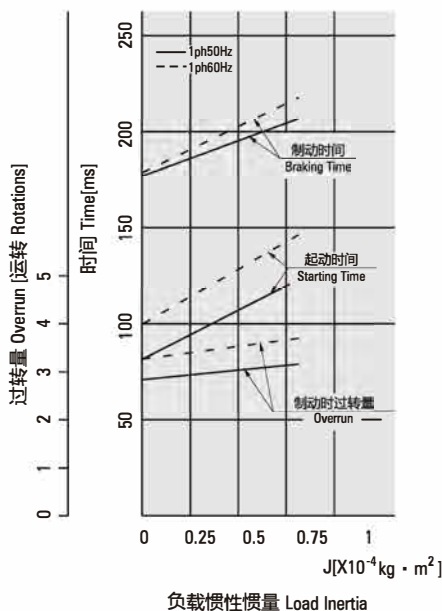

外形图 (单位 mm) Dimensions(Unit mm)

减速器附有安装用螺丝 Mounting screws are included with gearhead.

导线型 Lead Wiring Type

重量 Weight : 电动机 Motor : 3.55kg 减速器 Gearhead : 1.35kg

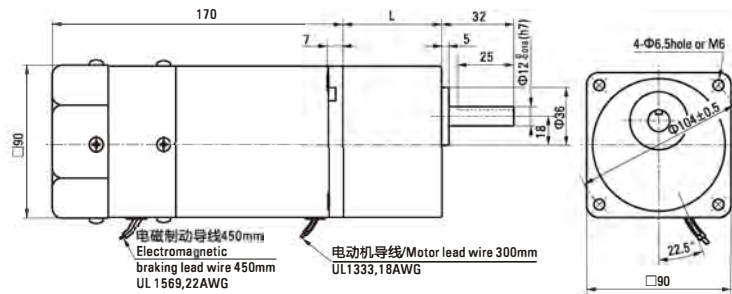

电动机型号 Motor Model	减速器型号 Gearhead Model	减速比 Gear Ratio	L1
5RK60GN-AFM	5GN□K	3~18	42
5RK60GN-EFM			
5RK60GN-CFM		25~200	60
5RK60GN-HFM			
5RK60GN-SFM			

● 减速器型号的□中为减速比的数值
Enter the gear ratio in the box (□) within the model name

键·键槽 (减速器附件) Key · Keyway(Accessory Of Gearhead)

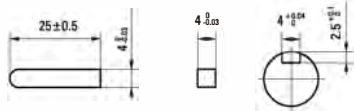

圆轴型的转轴部分 Shaft Section Of Round Shaft Type

除重量及轴部外电动机外形与齿轮轴型相同。
Excluding weight and the shaft section motor shape are the same as those of the pinion shaft type.

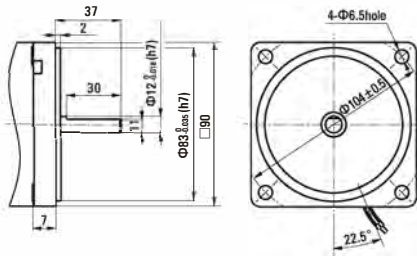

中间减速器 Decimal Gearhead

可安装在GN齿轮轴型上 Can be connected to GN pinion shaft type
电动机外形与齿轮轴型相同
5GN10XK

重量 Weight : 0.6kg

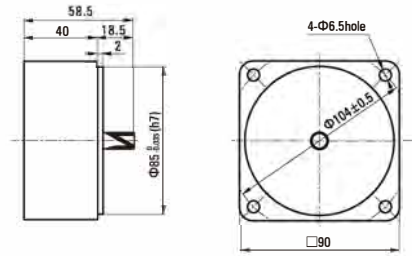

电容器外形尺寸 Formal Dimension Of Capacitor

型号 Model		电容器型号 Capacitor Model	L	W	H
齿轮轴型 Pinion Shaft	圆轴型 Round Shaft				
5RK60GN-AFM	5RK60A-AFM	ZD250CFAUL	47	27	37
5RK60GN-EFM	5RK60A-EFM	ZD150CFAUL	47	20	31
5RK60GN-CFM	5RK60A-CFM	ZD45BFAUL	47	19	31

● 常规电容器出线为引线,也可根据客户要求配置插片式187#

Note: Conventional capacitor is a lead wire type. Inserted 187# is optional

● 电动机型号的□中为表示带端子箱型的记号(T)

Enter the code that represents the terminal box type (T) in the box (□) within the model name

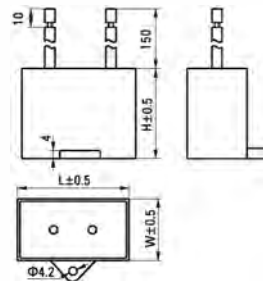

连接图 Wiring Diagram

- 运转方向指从电动机轴看来的方向。CW表示顺时针方向，CCW表示逆时针方向。
The direction of motor rotation is as viewed from the shaft end of motor. CW represents the clockwise direction, while CCW represents the counterclockwise direction.
- 表中所记品名为齿轮轴型，圆轴型亦同。Name indicated in the list is pinion shaft type, also valid for the equivalent round shaft type.

单相电动机 Single-phase Motor	
5RK60GN-AFM、5RK60GN-EFM、5RK60GN-CFM、5RK60GN-HFM	

SW1为电动机的运行/停止及电磁制动操作作用开关。(连动)
SW1 operates both motor and electromagnetic brake action. (Switched Simultaneously)
SW1设定于ON时，电磁制动解除，电动机开始运行。
The motor will rotate when SW1 is switched simultaneously to ON.
SW1设定于OFF时，电动机停止，电磁制动开始工作。
When SW1 is switched simultaneously to OFF, the motor stops immediately with the electromagnetic brake and holds the load.
在电动机停止状态下解除电磁制动时，应将SW1设定为非连动，而仅将黑色导线侧的触点设定为ON。
If you wish to release the brake while the motor is stopped, set the SW1 to off and connection point at the side of black lead to on.
运转方向。Direction of Rotation.
将SW2转换至CW侧时，电动机作顺时针方向运转。
To rotate the motor in a clockwise (CW) direction, turn SW2 to CW.
将SW2转换至CCW侧时，电动机作逆时针方向运转。
To rotate the motor in a counterclockwise (CCW) direction, turn SW2 to CCW.

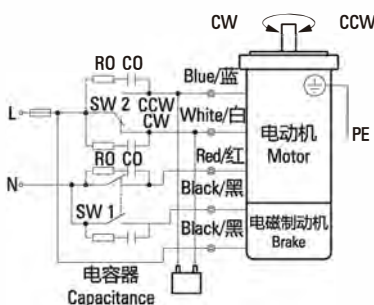

开关 号码 Switch No.	开关的触点容量Capacitor of Switch Connection Point		参考 Note
	单相100V、 110/120V输入 Single-Phase 100 VAC, 110/120 VAC Input	单相220V、 230V输入 Single-Phase 200 VAC, 220/230 VAC Input	
SW1	AC125V 3A以上 (感应负载) 125 VAC 3A minimum (Inductive Load)	AC250V 1.5A以上 (感应负载) 250 VAC 1.5A A minimum (Inductive Load)	连动Switched Simultaneously
SW2			

三相电动机 Three-phase Motor	
5RK60GN-SFM	

SW1为电动机的运行/停止及电磁制动操作作用开关。(连动)
SW1 operates both motor and electromagnetic brake action. (Switched Simultaneously)
SW1设定于ON时，电磁制动解除，电动机开始运行。
The motor will rotate when SW1 is switched simultaneously to ON.
SW1设定于OFF时，电动机停止，电磁制动开始工作。
When SW1 is switched simultaneously to OFF, the motor stops immediately with the electromagnetic brake and holds the load.
在电动机停止状态下解除电磁制动时，应将SW1设定为非连动，而仅将黑色导线侧的触点设定为ON。
If you wish to release the brake while the motor is stopped, set the SW1 to off and connection point at the side of black lead to on.
运转方向。Direction of Rotation.
若对换R、S、T中任意二条，电动机逆时针方向运转。
To change the rotation direction, change any two connections between R, S and T.

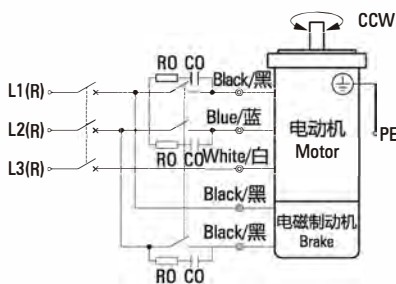

开关 号码 Switch No.	开关的触点容量Capacitor of Switch Connection Point	参考 Note
SW1	AC250V 1.5A以上 (感应负载) 250 VAC 1.5 A minimum (Inductive Load)	连动 Switched Simultaneously

请注意Notes:

- ROCO为吸收电涌电压用CR电路。[RO=5~200Ω、CO=0.1~0.2μF、200WV (400WV)] 请使用选购配件EPCR1201-2。
- RO and CO indicate surge suppressor circuit. [RO=5~200Ω, CO=0.1~0.2 μF, 200 WV (400 WV)] EPCR1201-2 is available as an optional surge suppressor.

无励磁动作型电磁制动电动机 POWER OFF ACTIVATED TYPE ELECTROMAGNETIC BRAKE MOTOR

■ 60W □ 90mm



规格 Specs / 电动机 Motor

- 没有内藏简易制动 This type of motor does not contain a built-in simple brake mechanism.

型号 Model · 类型 Type 导线型 Lead Wire Type	额定 Rating	输出功率 Output power	电压 Voltage	频率 Frequency	电流 Current	启动转矩 Starting Torque	额定转矩 Rated Torque	额定转速 Rated Speed	电容器容量 Capacitor
齿轮轴型 Pinion Shaft		W	V	Hz	A	mN.m	mN.m	r/min	μF
5RK60GU-AFM	30min	60	1ph 100	50	1.26	470	470	1250	25.0
				60	1.70		380	1550	
5RK60GU-EFM	30min	60	1ph 110	60	1.05	330	380	1550	15.0
			1ph 120		0.85	380			
5RK60GU-CFM	30min	60	1ph 220	50	0.55	420	470	1250	4.5
			1ph 230		0.60	460			
5RK60GU-HFM	30min	60	1ph 220	60	0.55	420	380	1550	
			1ph 230		0.60	460			
5RK60GU-SFM	30min	60	3ph 220	50	0.45	1000	470	1250	
				60	0.40	800	380	1550	

● 各种安全规格以电动机铭牌上的型号取得认定。

When the motor is approved under various safety standards, the model name on the nameplate is the approved model name.

● (D): 内藏热保护装置 (自动复位型)。在电动机因某种原因过热时会自行启动使电动机停止。

Contains a built-in thermal protector (automatic return). If a motor overheats for any reason, the thermal protector is opened and the motor stops.

● 电动机温度下降后会自动恢复运行，故在进行检查作业时请务必事先切断电源。

When the motor temperature drops, the thermal protector closes and the motor restarts. Be sure to turn the motor off before inspecting.

● 注：“-A”型号中电压为110V时，配置电容器容量以实际铭牌为准。

Note:“-A” it means the voltage 110v, the assembly capacitor value it is according to the label.

种类 Type

- 电动机 Motor

机型 Type	型号 Model
	齿轮轴型 Pinion Shaft
导线型 Lead Wire Type	5RK60GU-AFM
	5RK60GU-EFM
	5RK60GU-CFM
	5RK60GU-HFM
	5RK60GU-SFM

- 平行轴减速器 (另售) Parallel Shaft Gearhead (Sold Separately)

减速器种类 Gearhead Type	减速器型号 Gearhead Model	减速比 Gear Ratio
长寿命 ● 低噪音 Long Life ● Low Noise	5GU□KB	3、3.6、5、6、7.5、9、12.5、15、18、25、30、36、50、60、75、90、100、120、150、180、200
	5GU10XK (中间减速器 Decimal Gearhead)	

● 减速器型号的□中为减速比的数值

Enter the gear ratio in the box (□) within the model name

■ 装有减速器时的容许转矩 Gear Motor-Torque Table

- 减速器另售·中间减速器另售。电动机型号的□中为表示带端子箱型的记号(T)。
Gearhead and mid-gearbox can be sold separately. Enter the code that represents the terminal box type (T) in the box (□) within the model name.
- 减速品型号的□中为减速比的数值。
Enter the gear ratio in the box(□) within the model name.
- □色表示与电动机同一方向运转，其他则为相反方向。
The colored background □ indicates the same rotating direction of the motor while the rotating direction of others are opposite.
- 转速是以电动机的同步转速 (50Hz : 1500r/min、60Hz : 1800r/min) 为基准除以减速比而算出来的数值。实际转速将随负载大小变化所示数值减少2%~20%左右。
The speed is calculated by dividing the motor's synchronous speed (50Hz : 1500r/min、60Hz : 1800r/min) by the gear ratio. The actual speed is 2%~20% less than the displayed value, depending on the size of the load.
- 希望以大于下表的减速比进行进一步减速时，可在电动机与减速机之间安装减速比为10的中间减速机。这时的容许转矩为20N·m。
To reduce the speed beyond the gear ratio in the table, attach a decimal gearhead(gear ratio:10)between the gearhead and motor. In that case, the permissible torque is 20 N·m.

■ 容许力矩单位 Allowance Torque Unit : 上段 Upside (N.m) /下段 Belowside (kgf.cm)

类型 Type 电动机/减速机 Motor/Gearhead	减速比 Gear Ratio		3	3.6	5	6	7.5	9	12.5	15	18	25	30	36	50	60	75	90	100	120	150	180	200
	转速 Speed r/min	50Hz	500	417	300	250	200	166	120	100	83	60	50	41	30	25	20	16	15	12.5	10	8.3	7.5
		60Hz	600	500	360	300	240	200	144	120	100	72	60	50	36	30	24	20	18	15	12	10	9
5RK60GU-AFM 5RK60GU-EFM 5RK60GU-CFM 5RK60GU-HFM 5RK60GU-SFM	50Hz	5GU□KB	1.1	1.4	1.9	2.3	2.9	3.4	4.8	5.7	6.8	8.6	10.3	12.4	15.5	18.6	20	20	20	20	20	20	20
		5GU□K	11.2	14.2	19.3	23.4	29.6	34.7	48.9	58.1	69.3	87.7	105	126	158	189	200	200	200	200	200	200	200
	60Hz	5GU□KB	0.92	1.1	1.5	1.8	2.3	2.8	3.8	4.6	5.5	6.9	8.3	10	12.5	15	18.8	20	20	20	20	20	20
		5GU□K	9.38	11.2	15.3	18.3	23.4	28.5	38.7	46.9	56.1	70.4	84.7	102	127	153	192	200	200	200	200	200	200

■ 容许悬挂负载 · 容许轴向负载 To Allow The Hoisting Of The Load Allow Axial Load

电动机 (圆轴型) → 272页 Motor(Round Shaft) → P272
减速机 → 272页 Gearhead → P272

■ 减速机的容许负载惯性惯量 J Permissible Load Inertia J For Gearhead

→ 272页 → P272

■ 启动、制动特性 (参考值) Starting And Brake Characteristics(Reference Values)

- 单相电动机 Single-phase Motor
- 三相电动机 Three-phase Motor

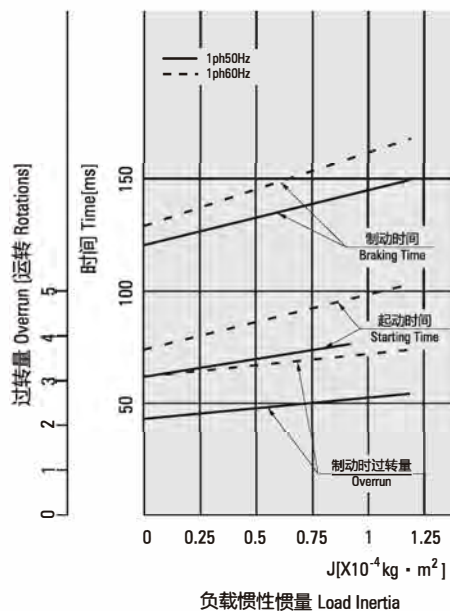
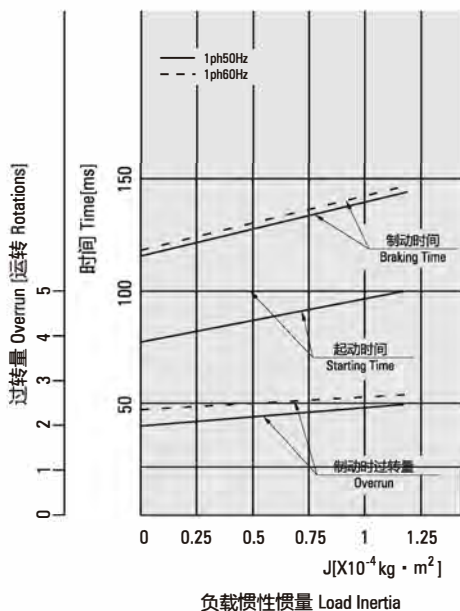

外形图 (单位 mm) Dimensions(Unit mm)

减速器附有安装用螺丝 Mounting screws are included with gearhead.

● 导线型 Lead Wiring Type

重量 Weight : 电动机 Motor : 3.55kg 减速器 Gearhead : 1.5kg

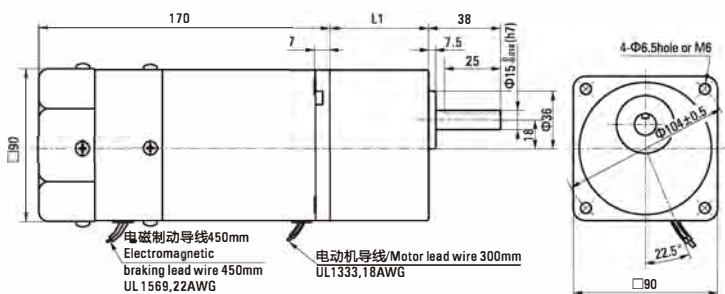

电动机型号 Motor Model	减速器型号 Gearhead Model	减速比 Gear Ratio	L1
5RK60GU-AFM	5GU□KB	3~200	65.5
5RK60GU-EFM			
5RK60GU-CFM			
5RK60GU-HFM			
5RK60GU-SFM			

● 减速器型号的□中为减速比的数值
Enter the gear ratio in the box (□) within the model name

● 凸缘安装型减速器 Flange Mounting Reducer

可安装在GU齿轮轴型上
Can be mounted on GU type gear shaft
5GU□K

重量 Weight: 1.5kg

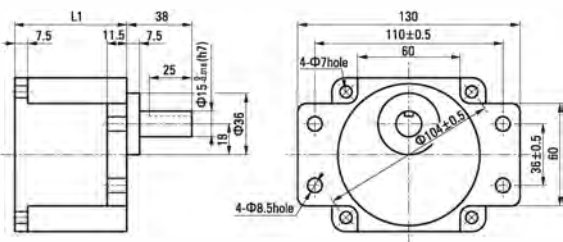

● 键·键槽 (减速器附件)

Key · Keyway (Accessory Of Gearhead)

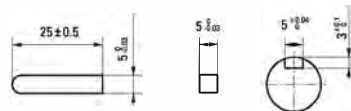

● 圆轴型的转轴部分 Shaft Section Of Round Shaft Type

除重量及轴部外电动机外形与齿轮轴型相同。
Excluding weight and the shaft section motor shape are the same as those of the pinion shaft type.

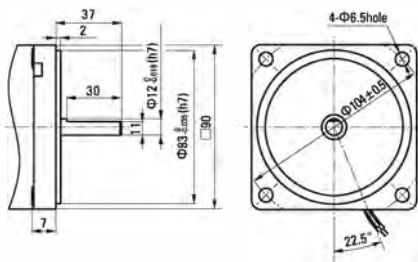

● 中间减速器 Decimal Gearhead

可安装在GU齿轮轴型上 Can be connected to GU pinion shaft type
电动机外形与齿轮轴型相同

5GU10XK
重量 Weight : 0.65kg

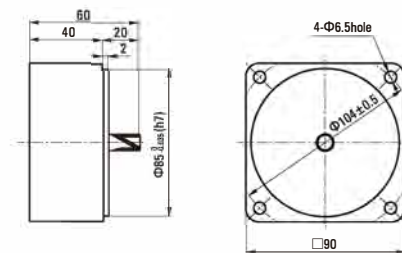

电容器外形尺寸 Formal Dimension Of Capacitor

型号 Model	电容器型号 Capacitor Model	L	W	H
5RK60GU-AFM	ZD250CFAUL	47	27	37
5RK60GU-EFM	ZD150CFAUL	47	20	31
5RK60GU-CFM	ZD45BFAUL	47	19	31

● 常规电容器出线为引线,也可根据客户要求配置插片式187#

Note: Conventional capacitor is a lead wire type. Inserted 187# is optional

● 电动机型号的□中为表示带端子箱型的记号(T)

Enter the code that represents the terminal box type (T) in the box (□) within the model name

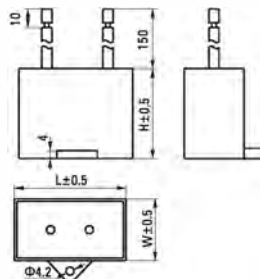

弧锥直角 SPIRAL BEVEL RIGHT ANGLE

■ 装有减速器时的容许转矩 Gear Motor-Torque Table

- 减速器·中间减速器另售。● 电动机型号的□中为表示带端子箱型的记号(T)。
Gearhead and mid-gearbox can be sold separately. Enter the code that represents the terminal box type (T) in the box (□) within the model name.
- 减速器型号的□中为减速比的数值。□色表示与电动机同一方向运转，其他则为相反方向。
Enter the gear ratio in the box (□) within the model name.
The colored background □ indicates the same rotating direction of the motor while the rotating direction of others are opposite.
- 转速是以电动机的同步转速 (50Hz:1500r/min、60Hz:1800r/min) 为基准除以减速比而算出来的数值。实际转速将随负载大小变化而比所示数值减少2%~20%左右。
The speed is calculated by dividing the motor's synchronous speed (50Hz:1500r/min、60Hz:1800r/min) by the gear ratio. The actual speed is 2%~20% less than the displayed value, depending on the size of the load.
- 希望以大于下表的减速比进行进一步减速时，可在电动机与减速器之间安装减速比为10的中间减速器。这时的容许转矩为20N·m。
To reduce the speed beyond the gear ratio in the table, attach a mid-gearbox (gear ratio:10) between the gearhead and motor. In that case, the permissible torque is 20N·m.

■ 容许力矩单位 Allowance Torque Unit: 上段 Upside (N.m) / 下段 Belowside (kgf.cm)

机型Type 电动机/减速器 Motor/Gearhead	减速比Gear Ratio	容许力矩 Allowance Torque																						
		3	3.6	5	6	7.5	9	12.5	15	18	25	30	3.6	50	60	75	90	100	120	150	180			
电动机/减速器 Motor/Gearhead	转速Speed r/min	50Hz	500	417	300	250	200	166	120	100	83	60	50	417	30	25	20	16	15	12	10	8		
	60Hz	600	500	360	300	240	200	144	120	100	72	60	500	36	30	24	20	18	15	12	10	10		
5RK60GU-AF□□ 5RK60GU-EF□□ 5RK60GU-CF□□ 5RK60GU-HF□□ 5RK60GU-SF□□	容许力矩 Allowance Torque	50Hz	5GU□RC	0.85	1.02	1.42	1.70	2.37	2.84	3.95	4.73	5.68	7.89	9.47	10.2	14.2	17.0	20.0	20.0	20.0	20.0	20.0	20.0	
			5GU□RT	8.70	10.4	14.5	17.4	24.2	29.0	40.3	48.3	58.0	80.5	96.6	104	145	174	200	200	200	200	200	200	200
		60Hz	5GU□RC	0.69	0.82	1.15	1.37	1.91	2.29	3.18	3.82	4.58	6.36	7.64	8.25	11.5	13.7	17.2	20.0	20.0	20.0	20.0	20.0	20.0
			5GU□RT	6.73	8.08	11.2	13.5	19.48	23.37	32.46	38.96	46.75	64.93	77.92	84.1	117	140	175	200	200	200	200	200	200

■ 刹车尺寸图 Brake Type Drawing

5RK60GU-AFM□/5GU□RC	5RK60GU-CFM□/5GU□RC	5RK60GU-AFM□/5GU□RT	5RK60GU-CFM□/5GU□RT
5RK60GU-EFM□/5GU□RC	5RK60GU-HFM□/5GU□RC	5RK60GU-EFM□/5GU□RT	5RK60GU-HFM□/5GU□RT
5RK60GU-SFM□/5GU□RC		5RK60GU-SFM□/5GU□RT	

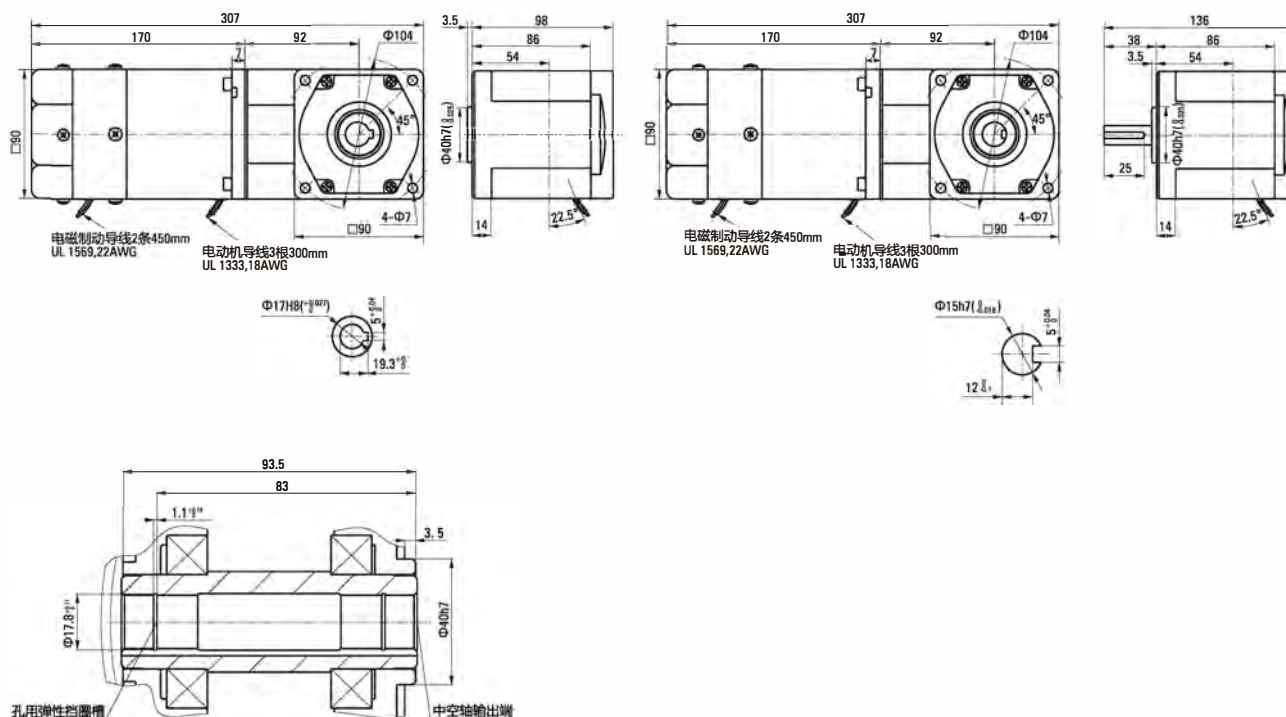

蜗轮蜗杆直角 WORM GEAR RIGHT ANGLE

■ 装有减速器时的容许转矩 Gear Motor-Torque Table

- 减速器-中间减速器另售。● 电动机型号的□中为表示带端子箱型的记号(T)。
Gearhead and mid-gearbox can be sold separately. Enter the code that represents the terminal box type (T) in the box (□) within the model name.
- 减速器型号的□中为减速比的数值。□色表示与电动机同一方向运转，其他则为相反方向。
Enter the gear ratio in the box (□) within the model name.
The colored background □ indicates the same rotating direction of the motor while the rotating direction of others are opposite.
- 转速是以电动机的同步转速 (50Hz:1500r/min、60Hz:1800r/min) 为基准除以减速比而算出来的数值。实际转速将随负载大小变化而比所示数值减少2%~20%左右。
The speed is calculated by dividing the motor's synchronous speed (50Hz:1500r/min、60Hz:1800r/min) by the gear ratio. The actual speed is 2%~20% less than the displayed value, depending on the size of the load.
- 希望以大于下表的减速比进行进一步减速时，可在电动机与减速器之间安装减速比为10的中间减速器。这时的容许转矩为20N·m。
To reduce the speed beyond the gear ratio in the table, attach a mid-gearbox (gear ratio:10) between the gearhead and motor. In that case, the permissible torque is 20N·m.

■ 容许力矩单位 Allowance Torque Unit: 上段 Upside (N.m) / 下段 Belowside (kgf.cm)

机型Type	减速比Gear Ratio	3	3.6	5	6	7.5	9	12.5	15	18	25	30	3.6	50	60	75	90	100	120	150	180			
电动机/减速器 Motor/Gearhead	转速Speed r/min	50Hz	500	417	300	250	200	166	120	100	83	60	50	417	30	25	20	16	15	12	10	8		
	60Hz	600	500	360	300	240	200	144	120	100	72	60	500	36	30	24	20	18	15	12	10			
5RK60GU-AF□M 5RK60GU-EF□M 5RK60GU-CF□M 5RK60GU-HF□M 5RK60GU-SF□M	容许力矩 Allowance Torque	50Hz	5GU□RH	0.62	0.74	0.93	1.11	1.39	1.67	2.32	2.78	3.34	4.64	5.57	6.68	9.28	11.1	13.9	16.7	18.6	20.0	20.0	20.0	
			5GU□RA	6.31	7.58	9.47	11.4	14.2	17.0	23.7	28.4	34.1	47.4	56.8	68.2	94.7	114	142	170	189	200	200	200	
		60Hz	5GU□RH	0.50	0.60	0.75	0.90	1.12	1.35	1.87	2.25	2.69	3.74	4.49	5.39	7.49	8.98	11.2	13.5	15.0	18.0	20.0	20.0	20.0
			5GU□RA	5.09	6.11	7.64	9.17	11.5	13.7	19.1	22.9	27.5	38.2	45.8	55.0	76.4	91.7	115	137	153	183	200	200	200

■ 刹车尺寸图 Brake Type Drawing

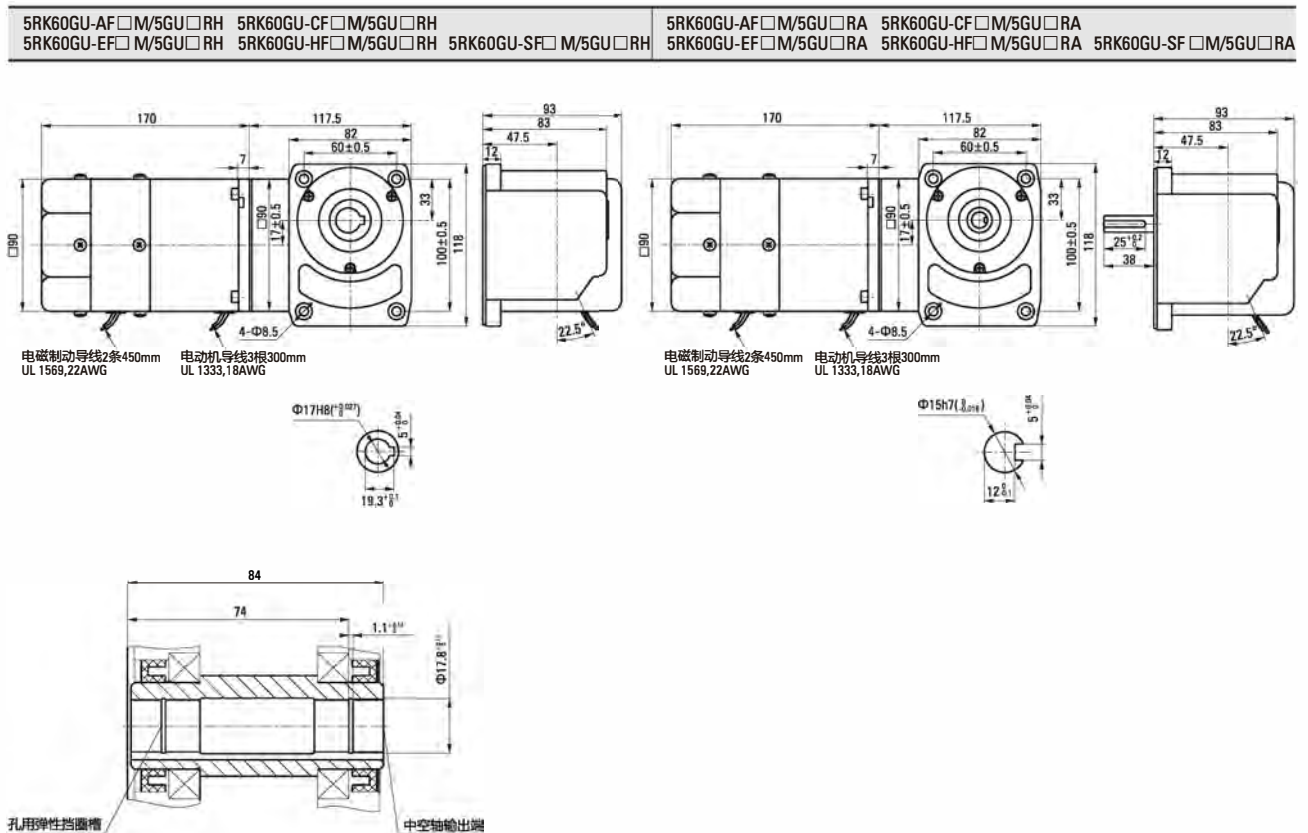

连接图 Wiring Diagram

●运转方向指从电动机轴看来的方向。CW表示顺时针方向，CCW表示逆时针方向。

The direction of motor rotation is as viewed from the shaft end of motor. CW represents the clockwise direction, while CCW represents the counterclockwise direction.

●表中所记品名为齿轮轴型，圆轴型亦同。Name indicated in the list is pinion shaft type, also valid for the equivalent round shaft type.

单相电动机 Single-phase Motor	
5RK60GU-AFM、5RK60GU-EFM、5RK60GU-CFM、5RK60GU-HFM	

SW1为电动机的运行/停止及电磁制动操作作用开关。（连动）

SW1 operates both motor and electromagnetic brake action. (Switched Simultaneously)

SW1设定于ON时，电磁制动解除，电动机开始运行。

The motor will rotate when SW1 is switched simultaneously to ON.

SW1设定于OFF时，电动机停止，电磁制动开始工作。

When SW1 is switched simultaneously to OFF, the motor stops immediately with the electromagnetic brake and holds the load.

在电动机停止状态下解除电磁制动时，应将SW1设定为非连动，而仅将黑色导线侧的触点设定为ON。

If you wish to release the brake while the motor is stopped, set the SW1 to off and connection point at the side of black lead to on.

运转方向。Direction of Rotation.

将SW2转换至CW侧时，电动机作顺时针方向运转。

To rotate the motor in a clockwise (CW) direction, turn SW2 to CW.

将SW2转换至CCW侧时，电动机作逆时针方向运转。

To rotate the motor in a counterclockwise (CCW) direction, turn SW2 to CCW.

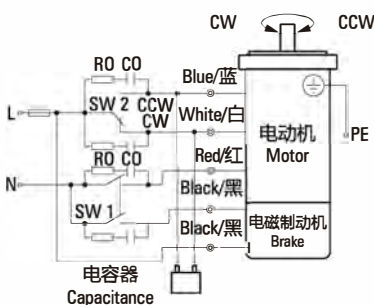

开关 号码 Switch No.	开关的触点容量Capacitor of Switch Connection Point		参考 Note
	单相100V、 110/120V输入 Single-Phase 100 VAC, 110/120 VAC Input	单相220V、 230V输入 Single-Phase 200 VAC, 220/230 VAC Input	
SW1	AC125V 3A以上 (感应负载) 125 VAC 3A minimum (Inductive Load)	AC250V 1.5A以上 (感应负载) 250 VAC 1.5A A minimum (Inductive Load)	连动Switched Simultaneously
SW2			-

三相电动机 Three-phase Motor	
5RK60GU-SFM	

SW1为电动机的运行/停止及电磁制动操作作用开关。（连动）

SW1 operates both motor and electromagnetic brake action. (Switched Simultaneously)

SW1设定于ON时，电磁制动解除，电动机开始运行。

The motor will rotate when SW1 is switched simultaneously to ON.

SW1设定于OFF时，电动机停止，电磁制动开始工作。

When SW1 is switched simultaneously to OFF, the motor stops immediately with the electromagnetic brake and holds the load.

在电动机停止状态下解除电磁制动时，应将SW1设定为非连动，而仅将黑色导线侧的触点设定为ON。

If you wish to release the brake while the motor is stopped, set the SW1 to off and connection point at the side of black lead to on.

运转方向。Direction of Rotation.

若对换R、S、T中任意二条，电动机逆时针方向运转。

To change the rotation direction, change any two connections between R, S and T.

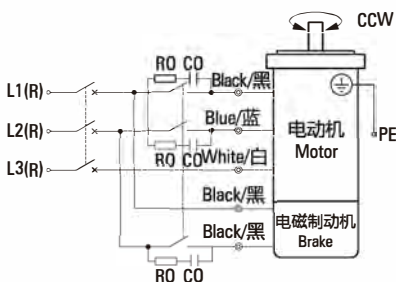

开关 号码 Switch No.	开关的触点容量Capacitor of Switch Connection Point	参考 Note
SW1	AC250V 1.5A以上 (感应负载) 250 VAC 1.5 A minimum (Inductive Load)	连动 Switched Simultaneously

请注意Notes:

●R0C0为吸收电涌电压用CR电路。[R0=5~200Ω、C0=0.1~0.2μF、200WV (400WV)] 请使用选购配件EPCR1201-2。

●R0 and C0 indicate surge suppressor circuit. [R0=5~200Ω, C0=0.1~0.2 μ F, 200 WV (400 WV)] EPCR1201-2 is available as an optional surge suppressor.

无励磁动作型电磁制动电动机

POWER OFF ACTIVATED TYPE ELECTROMAGNETIC BRAKE MOTOR

■ 90W □ 90mm



规格 Specs / 电动机 Motor

- 没有内藏简易制动 This type of motor does not contain a built-in simple brake mechanism.

型号 Model · 类型 Type 导线型 Lead Wire Type		额定 Rating	输出功率 Output power	电压 Voltage	频率 Frequency	电流 Current	启动转矩 Starting Torque	额定转矩 Rated Torque	额定转速 Rated Speed	电容器容量 Capacitor
齿轮轴型 Pinion Shaft	圆轴型 Round Shaft									
5RK90GU-AFM	5RK90A-AFM	30min	90	1ph 100	50	1.78	600	700	1250	30.0
					60	2.35		570	1550	
5RK90GU-EFM	5RK90A-EFM	30min	90	1ph 110	60	1.72	550	570	1550	25.0
				1ph 120			600			
5RK90GU-CFM	5RK90A-CFM	30min	90	1ph 220	50	0.82	560	700	1250	6.0
				1ph 230		0.81				
5RK90GU-HFM	5RK90A-HFM	30min	90	1ph 220	60	0.81	560	570	1550	-
				1ph 230		0.80				
5RK90GU-SFM	5RK90A-SFM	30min	90	3ph 220	50	0.60	1350	700	1250	-
					60	0.55	1100	570	1550	

- 各种安全规格以电动机铭牌上的型号取得认定。
When the motor is approved under various safety standards, the model name on the nameplate is the approved model name.
- (T): 内藏热保护装置 (自动复位型)。在电动机因某种原因过热时会自行启动使电动机停止。
Contains a built-in thermal protector(automatic return). If a motor overheats for any reason, the thermal protector is opened and the motor stops.
- 电动机温度下降后会自行恢复运行, 故在进行检查作业时请务必先切断电源。
When the motor temperature drops, the thermal protector closes and the motor restarts. Be sure to turn the motor off before inspecting.
- 注: "-A" 型号中电压为110V时, 配置电容器容量以实际铭牌为准。
Note: "-A" it means the voltage 110v,the assembly capacitor vaule it is according the labe.

种类 Type

- 电动机 Motor

机型 Type	型号 Model	
	齿轮轴型 Pinion Shaft	圆轴型 Round Shaft
导线型 Lead Wire Type	5RK90GU-AFM	5RK90A-AFM
	5RK90GU-EFM	5RK90A-EFM
	5RK90GU-CFM	5RK90A-CFM
	5RK90GU-HFM	5RK90A-HFM
	5RK90GU-SFM	5RK90A-SFM

- 平行轴减速器 (另售) Parallel Shaft Gearhead (Sold Separately)

减速器种类 Gearhead Type	减速器型号 Gearhead Model	减速比 Gear Ratio
长寿命●低噪音 Long Life ● Low Noise	5GU□KB	3、3.6、5、6、7.5、9、 12.5、15、18、25、30、 36、50、60、75、90、 100、120、150、180、200
	5GU10XK (中间减速器 Decimal Gearhead)	

- 减速器型号的□中为减速比的数值
Enter the gear ratio in the box (□) within the model name

■ 装有减速器时的容许转矩 Gear Motor-Torque Table

- 减速器另售·中间减速器另售。电动机型号的□中为表示带端子箱型的记号(T)。
Gearhead and mid-gearbox can be sold separately. Enter the code that represents the terminal box type (T) in the box (□) within the model name.
- 减速品型号的□中为减速比的数值。
Enter the gear ratio in the box(□) within the model name.
- □色表示与电动机同一方向运转，其他则为相反方向。
The colored background □ indicates the same rotating direction of the motor while the rotating direction of others are opposite.
- 转速是以电动机的同步转速 (50Hz : 1500r/min、60Hz : 1800r/min) 为基准除以减速比而算出来的数值。实际转速将随负载大小变化所示数值减少2%~20%左右。
The speed is calculated by dividing the motor's synchronous speed (50Hz : 1500r/min、60Hz : 1800r/min) by the gear ratio. The actual speed is 2%~20% less than the displayed value, depending on the size of the load.
- 希望以大于下表的减速比进行进一步减速时，可在电动机与减速机之间安装减速比为10的中间减速机。这时的容许转矩为20N·m。
To reduce the speed beyond the gear ratio in the table, attach a decimal gearhead(gear ratio:10)between the gearhead and motor. In that case, the permissible torque is 20 N·m.

■ 容许力矩单位 Allowance Torque Unit : 上段 Upside (N.m) /下段 Belowside (kgf.cm)

类型 Type 电动机/减速机 Motor/Gearhead	减速比 Gear Ratio		3	3.6	5	6	7.5	9	12.5	15	18	25	30	36	50	60	75	90	100	120	150	180	200
	转速 Speed r/min	50Hz	500	417	300	250	200	166	120	100	83	60	50	41	30	25	20	16	15	12.5	10	8.3	7.5
		60Hz	600	500	360	300	240	200	144	120	100	72	60	50	36	30	24	20	18	15	12	10	9
5RK90GU-AFM 5RK90GU-EFM 5RK90GU-CFM 5RK90GU-HFM 5RK90GU-SFM	5GU□KB 5GU□K	50Hz	1.7	2.0	2.8	3.4	4.3	5.1	6.4	7.7	9.2	11.6	13.9	16.6	20	20	20	20	20	20	20	20	20
		60Hz	1.4	1.7	2.3	2.8	3.5	4.2	5.2	6.2	7.5	9.4	11.3	13.5	18.8	20	20	20	20	20	20	20	20
			14.3	17.3	23.5	28.6	35.7	42.9	53.1	63.3	76.5	95.9	115	128	192	200	200	200	200	200	200	200	200

■ 容许悬挂负载 · 容许轴向负载 To Allow The Hoisting Of The Load Allow Axial Load

电动机 (圆轴型) → 272页 Motor(Round Shaft) → P272
 减速机 → 272页 Gearhead → P272

■ 减速机的容许负载惯性惯量 J Permissible Load Inertia J For Gearhead

→ 272页 → P272

■ 起动、制动特性 (参考值) Starting And Brake Characteristics(Reference Values)

- 单相电动机 Single-phase Motor
- 三相电动机 Three-phase Motor

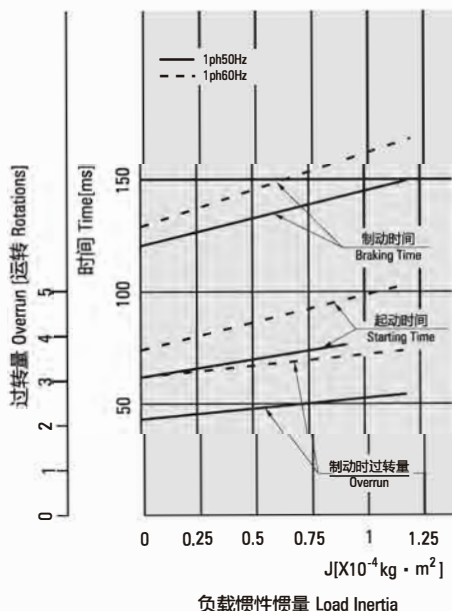
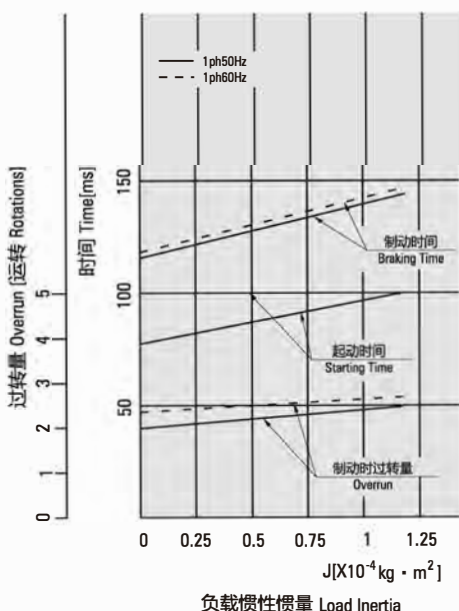

外形图 (单位 mm) Dimensions(Unit mm)

减速器附有安装用螺丝 Mounting screws are included with gearhead.

● 导线型 Lead Wiring Type

重量 Weight : 电动机 Motor : 4.3kg 减速器 Gearhead : 1.5kg

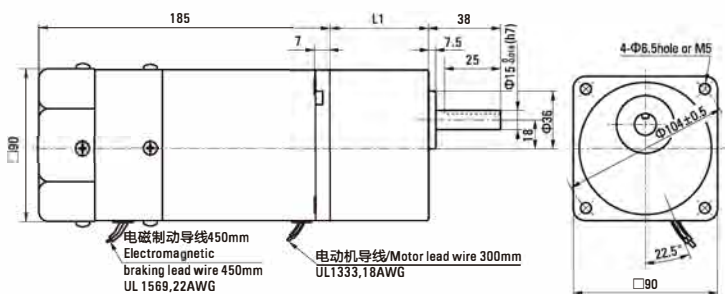

电动机型号 Motor Model	减速器型号 Gearhead Model	减速比 Gear Ratio	L1
5RK90GU-AFM	5GU□KB	3~200	65.5
5RK90GU-EFM			
5RK90GU-CFM			
5RK90GU-HFM			
5RK90GU-SFM			

● 减速器型号的□中为减速比的数值
Enter the gear ratio in the box (□) within the model name

● 凸缘安装型减速器 Flange Mounting Reducer

可安装在GU齿轮轴型上
Can be mounted on GU type gear shaft
5GU□K
重量 Weight: 1.5kg

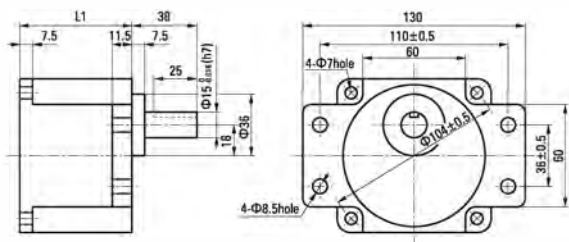

● 键·键槽 (减速器附件)

Key · Keyway (Accessory Of Gearhead)

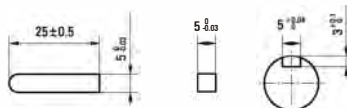

● 圆轴型的转轴部分 Shaft Section Of Round Shaft Type

除重量及轴部外电动机外形与齿轮轴型相同。
Excluding weight and the shaft section motor shape are the same as those of the pinion shaft type.

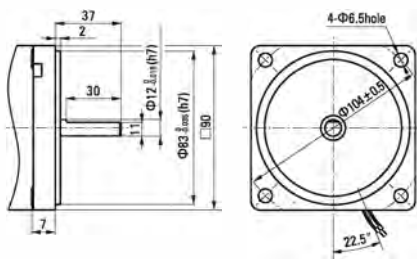

● 中间减速器 Decimal Gearhead

可安装在GU齿轮轴型上 Can be connected to GU pinion shaft type
电动机外形与齿轮轴型相同
5GU10XK
重量 Weight : 0.65kg

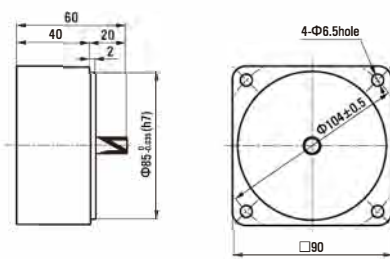

电容器外形尺寸 Formal Dimension Of Capacitor

型号 Model		电容器型号 Capacitor Model	L	W	H
齿轮轴型 Pinion Shaft	圆轴型 Round Shaft				
5RK90GU-AFM	5RK90A-AFM	ZD300CFAUL	58	26	38
5RK90GU-EFM	5RK90A-EFM	ZD250CFAUL	47	27	37
5RK90GU-CFM	5RK90A-CFM	ZD60BFAUL	48	23	32

● 常规电容器出线为引线,也可根据客户要求配置插片式187#

Note: Conventional capacitor is a lead wire type. Inserted 187# is optional

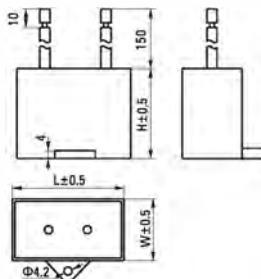

弧锥直角 SPIRAL BEVEL RIGHT ANGLE

■ 装有减速器时的容许转矩 Gear Motor-Torque Table

- 减速器·中间减速器另售。● 电动机型号的□中为表示带端子箱型的记号(T)。
Gearhead and mid-gearbox can be sold separately. Enter the code that represents the terminal box type (T) in the box (□) within the model name.
- 减速器型号的□中为减速比的数值。□色表示与电动机同一方向运转，其他则为相反方向。
Enter the gear ratio in the box (□) within the model name.
The colored background □ indicates the same rotating direction of the motor while the rotating direction of others are opposite.
- 转速是以电动机的同步转速 (50Hz:1500r/min、60Hz:1800r/min) 为基准除以减速比而算出来的数值。实际转速将随负载大小变化而比所示数值减少2%~20%左右。
The speed is calculated by dividing the motor's synchronous speed (50Hz:1500r/min、60Hz:1800r/min) by the gear ratio. The actual speed is 2%~20% less than the displayed value, depending on the size of the load.
- 希望以大于下表的减速比进行进一步减速时，可在电动机与减速器之间安装减速比为10的中间减速器。这时的容许转矩为20N·m。
To reduce the speed beyond the gear ratio in the table, attach a mid-gearbox (gear ratio:10) between the gearhead and motor. In that case, the permissible torque is 20N·m.

■ 容许力矩单位 Allowance Torque Unit: 上段 Upside (N.m) / 下段 Belowside (kgf.cm)

机型Type 电动机/减速器 Motor/Gearhead	减速比Gear Ratio	容许力矩 Allowance Torque																					
		3	3.6	5	6	7.5	9	12.5	15	18	25	30	3.6	50	60	75	90	100	120	150	180		
5RK90GU-AF□□ 5RK90GU-EF□□ 5RK90GU-CF□□ 5RK90GU-HF□□ 5RK90GU-SF□□	5GU□RC 5GU□RT	转速Speed r/min	50Hz	500	417	300	250	200	166	120	100	83	60	50	417	30	25	20	16	15	12	10	8
			60Hz	600	500	360	300	240	200	144	120	100	72	60	500	36	30	24	20	18	15	12	10
5RK90GU-AF□□ 5RK90GU-EF□□ 5RK90GU-CF□□ 5RK90GU-HF□□ 5RK90GU-SF□□	5GU□RC 5GU□RT	容许力矩 Allowance Torque	50Hz	1.28	1.53	2.13	2.56	3.55	4.26	5.92	7.10	8.52	11.8	14.2	15.3	20.0	20.0	20.0	20.0	20.0	20.0	20.0	20.0
			60Hz	1.03	1.24	1.72	2.06	2.86	3.44	4.77	5.73	6.87	9.54	11.5	12.4	17.2	20.0	20.0	20.0	20.0	20.0	20.0	20.0

■ 刹车尺寸图 Brake Type Drawing

5RK90GU-AF□□M/5GU□RC 5RK90GU-CF□□M/5GU□RC 5RK90GU-SF□□M/5GU□RC 5RK90GU-AF□□M/5GU□RT 5RK90GU-CF□□M/5GU□RT 5RK90GU-HF□□M/5GU□RT 5RK90GU-EF□□M/5GU□RC 5RK90GU-HF□□M/5GU□RC 5RK90GU-SF□□M/5GU□RT

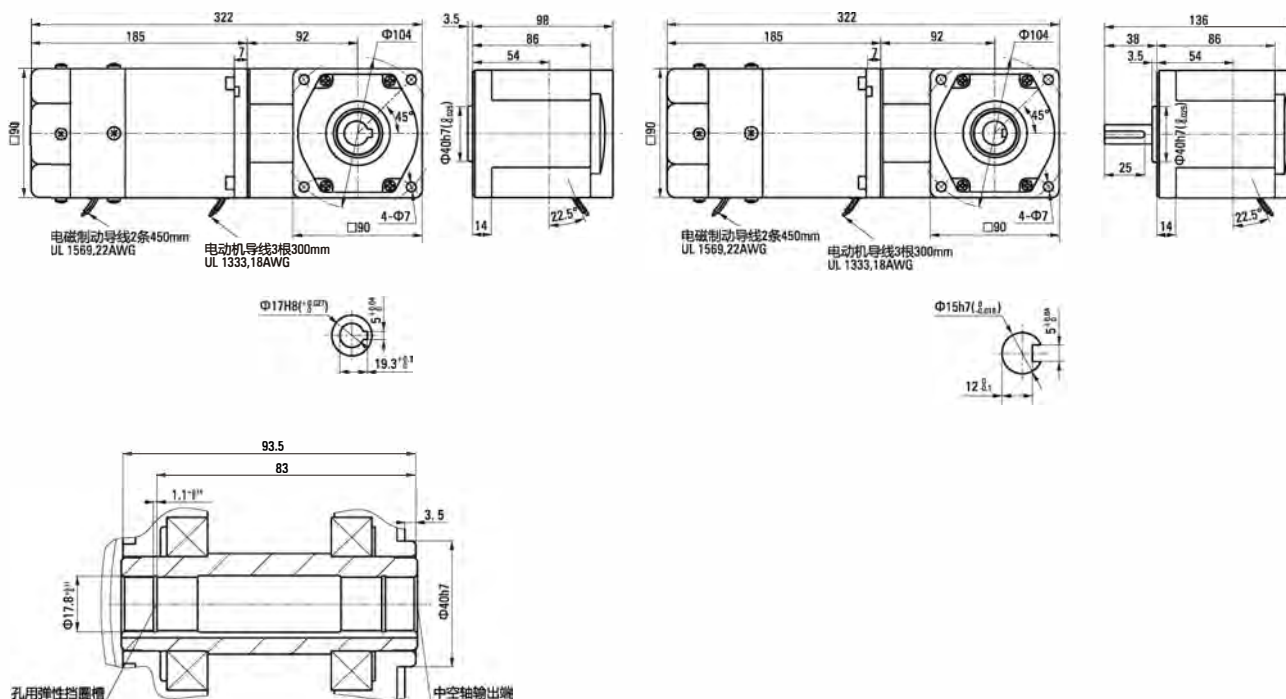

蜗轮蜗杆直角 WORM GEAR RIGHT ANGLE

■ 装有减速器时的容许转矩 Gear Motor-Torque Table

- 减速器-中间减速器另售。● 电动机型号的□中为表示带端子箱型的记号(T)。
Gearhead and mid-gearbox can be sold separately. Enter the code that represents the terminal box type (T) in the box (□) within the model name.
- 减速器型号的□中为减速比的数值。□色表示与电动机同一方向运转，其他则为相反方向。
Enter the gear ratio in the box (□) within the model name.
The colored background □ indicates the same rotating direction of the motor while the rotating direction of others are opposite.
- 转速是以电动机的同步转速 (50Hz:1500r/min、60Hz:1800r/min) 为基准除以减速比而算出来的数值。实际转速将随负载大小变化而比所示数值减少2%~20%左右。
The speed is calculated by dividing the motor's synchronous speed (50Hz:1500r/min、60Hz:1800r/min) by the gear ratio. The actual speed is 2%~20% less than the displayed value, depending on the size of the load.
- 希望以大于下表的减速比进行进一步减速时，可在电动机与减速器之间安装减速比为10的中间减速器。这时的容许转矩为20N·m。
To reduce the speed beyond the gear ratio in the table, attach a mid-gearbox (gear ratio:10) between the gearhead and motor. In that case, the permissible torque is 20N·m.

■ 容许力矩单位 Allowance Torque Unit: 上段 Upside (N.m) / 下段 Belowside (kgf.cm)

机型Type	减速比Gear Ratio	3	3.6	5	6	7.5	9	12.5	15	18	25	30	3.6	50	60	75	90	100	120	150	180		
电动机/减速器 Motor/Gearhead	转速Speed r/min	50Hz	500	417	300	250	200	166	120	100	83	60	50	417	30	25	20	16	15	12	10	8	
	60Hz	600	500	360	300	240	200	144	120	100	72	60	500	36	30	24	20	18	15	12	10		
5RK90GU-AF□M 5RK90GU-EF□M 5RK90GU-CF□M 5RK90GU-HF□M 5RK90GU-SF□M	5GU□RH 5GU□RA	容许力矩 Allowance Torque	50Hz	0.93	1.11	1.39	1.67	2.09	2.51	3.48	4.18	5.01	6.96	8.35	10.0	13.9	16.7	20.0	20.0	20.0	20.0	20.0	20.0
			60Hz	0.75	0.90	1.12	1.35	1.68	2.02	2.81	3.37	4.04	5.61	6.74	8.08	11.2	13.5	16.8	20.0	20.0	20.0	20.0	20.0
			50Hz	7.64	9.17	11.5	13.7	17.2	20.6	28.6	34.4	41.2	57.3	68.7	82.5	115	137	172	200	200	200	200	200
			60Hz	7.64	9.17	11.5	13.7	17.2	20.6	28.6	34.4	41.2	57.3	68.7	82.5	115	137	172	200	200	200	200	200

■ 刹车尺寸图 Brake Type Drawing

5RK90GU-AF□M/5GU□RH	5RK90GU-CF□M/5GU□RH	5RK90GU-EF□M/5GU□RH	5RK90GU-HF□M/5GU□RH	5RK90GU-SF□M/5GU□RH	5RK90GU-AF□M/5GU□RA	5RK90GU-CF□M/5GU□RA	5RK90GU-EF□M/5GU□RA	5RK90GU-HF□M/5GU□RA	5RK90GU-SF□M/5GU□RA
---------------------	---------------------	---------------------	---------------------	---------------------	---------------------	---------------------	---------------------	---------------------	---------------------

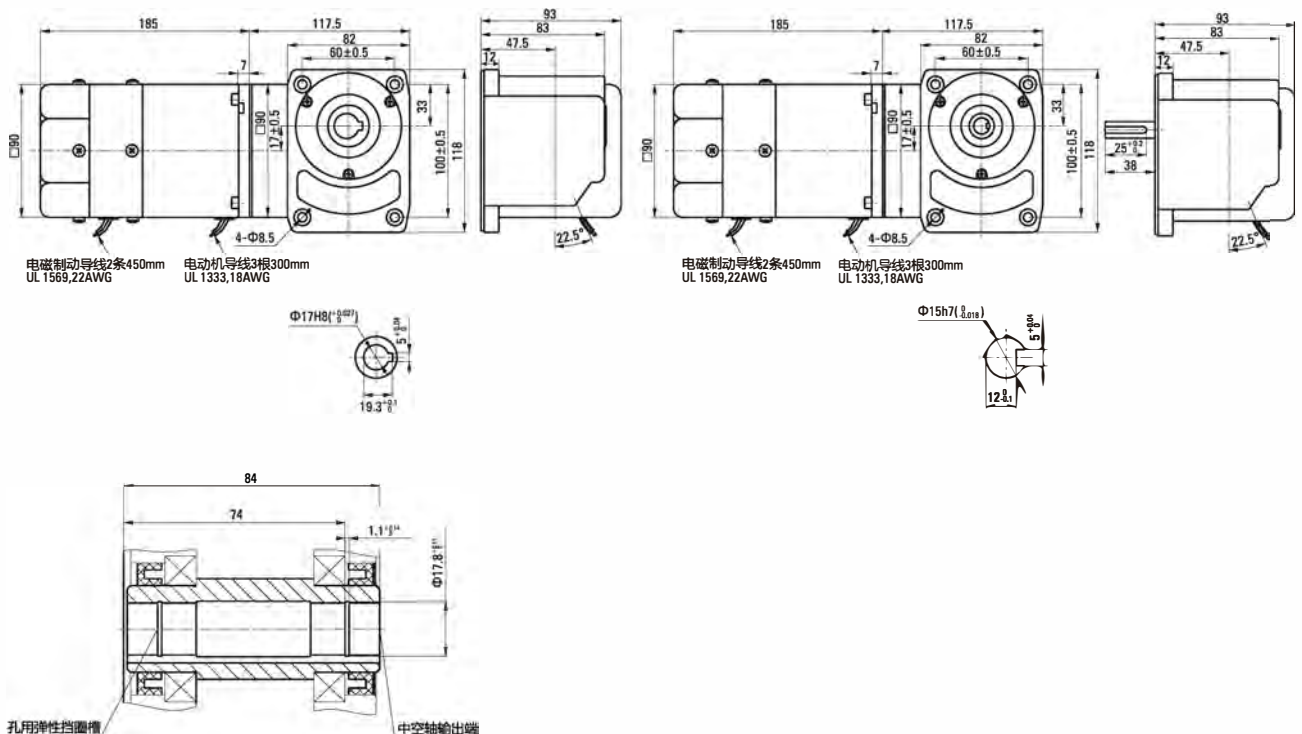

连接图 Wiring Diagram

●运转方向指从电动机轴看来的方向。CW表示顺时针方向，CCW表示逆时针方向。

The direction of motor rotation is as viewed from the shaft end of motor. CW represents the clockwise direction, while CCW represents the counterclockwise direction.

●表中所记品名为齿轮轴型，圆轴型亦同。Name indicated in the list is pinion shaft type, also valid for the equivalent round shaft type.

单相电动机 Single-phase Motor	
5RK90GU-AFM、5RK90GU-EFM、5RK90GU-CFM、5RK90GU-HFM	

SW1为电动机的运行/停止及电磁制动操作作用开关。(连动)

SW1 operates both motor and electromagnetic brake action. (Switched Simultaneously)

SW1设定于ON时，电磁制动解除，电动机开始运行。

The motor will rotate when SW1 is switched simultaneously to ON.

SW1设定于OFF时，电动机停止，电磁制动开始工作。

When SW1 is switched simultaneously to OFF, the motor stops immediately with the electromagnetic brake and holds the load.

在电动机停止状态下解除电磁制动时，应将SW1设定为非连动，而仅将黑色导线侧的触点设定为ON。

If you wish to release the brake while the motor is stopped, set the SW1 to off and connection point at the side of black lead to on.

运转方向。Direction of Rotation.

将SW2转换至CW侧时，电动机作顺时针方向运转。

To rotate the motor in a clockwise (CW) direction, turn SW2 to CW.

将SW2转换至CCW侧时，电动机作逆时针方向运转。

To rotate the motor in a counterclockwise (CCW) direction, turn SW2 to CCW.

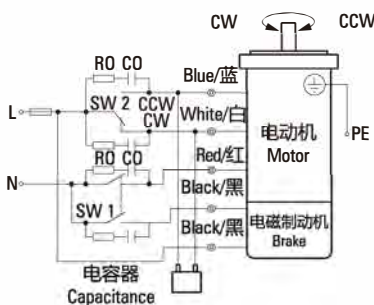

开关 号码 Switch No.	开关的触点容量Capacitor of Switch Connection Point		参考 Note
	单相100V、 110/120V输入 Single-Phase 100 VAC, 110/120 VAC Input	单相220V、 230V输入 Single-Phase 200 VAC, 220/230 VAC Input	
SW1	AC125V 8A以上 (感应负载) 125 VAC 8A minimum (Inductive Load)	AC250V 8A以上 (感应负载) 250 VAC 8A A minimum (Inductive Load)	连动Switched Simultaneously
SW2			

三相电动机 Three-phase Motor	
5RK60GU-SFM	

SW1为电动机的运行/停止及电磁制动操作作用开关。(连动)

SW1 operates both motor and electromagnetic brake action. (Switched Simultaneously)

SW1设定于ON时，电磁制动解除，电动机开始运行。

The motor will rotate when SW1 is switched simultaneously to ON.

SW1设定于OFF时，电动机停止，电磁制动开始工作。

When SW1 is switched simultaneously to OFF, the motor stops immediately with the electromagnetic brake and holds the load.

在电动机停止状态下解除电磁制动时，应将SW1设定为非连动，而仅将黑色导线侧的触点设定为ON。

If you wish to release the brake while the motor is stopped, set the SW1 to off and connection point at the side of black lead to on.

运转方向。Direction of Rotation.

若对换R、S、T中任意二条，电动机逆时针方向运转。

To change the rotation direction, change any two connections between R, S and T.

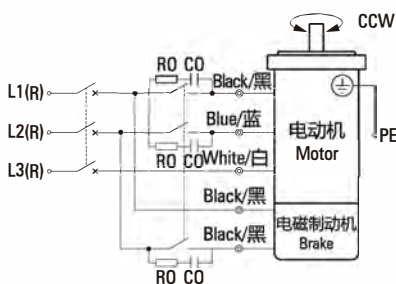

开关 号码 Switch No.	开关的触点容量Capacitor of Switch Connection Point		参考 Note
SW1	AC250V 1.5A以上 (感应负载) 250 VAC 1.5 A minimum (Inductive Load)		连动 Switched Simultaneously

请注意Notes:

●ROCO为吸收电涌电压用CR电路。[RO=5~200Ω、CO=0.1~0.2μF、200WV (400WV)] 请使用选购配件EPCR1201-2。

●RO and CO indicate surge suppressor circuit. [RO=5~200Ω, CO=0.1~0.2 μ F, 200 WV (400 WV)] EPCR1201-2 is available as an optional surge suppressor.

无励磁动作型电磁制动电动机

POWER OFF ACTIVATED TYPE ELECTROMAGNETIC BRAKE MOTOR

■ 120W □ 90mm



■ 规格 Specs / 电动机 Motor

- 没有内藏简易制动 This type of motor does not contain a built-in simple brake mechanism.

型号 Model · 类型 Type 导线型 Lead Wire Type		额定 Rating	输出功率 Output power	电压 Voltage	频率 Frequency	电流 Current	启动转矩 Starting Torque	额定转矩 Rated Torque	额定转速 Rated Speed	电容器容量 Capacitor
齿轮轴型 Pinion Shaft	圆轴型 Round Shaft									
5RK120GU-AFM	5RK120A-AFM	30min	120	1ph 100	50	2.25	700	930	1250	35
					60	2.85		750	1550	
5RK120GU-EFM	5RK120A-EFM	30min	120	1ph 110 1ph 120	60	1.90	650	750	1550	30
							720			
5RK120GU-CFM	5RK120A-CFM	30min	120	1ph 220 1ph 230	50	1.15	720	930	1250	8.0
5RK120GU-HFM	5RK120A-HFM	30min	120	3ph 220	50	0.70	1850	930	1250	-
					60	0.60				

- 各种安全规格以电动机铭牌上的型号取得认定。

When the motor is approved under various safety standards, the model name on the nameplate is the approved model name.

- (Ⓢ)：内藏热保护装置（自动复位型）。在电动机因某种原因过热时会自行起动作使电动机停止。
Contains a built-in thermal protector(automatic return). If a motor overheats for any reason, the thermal protector is opened and the motor stops.
- 电动机温度下降后会自行恢复运行，故在进行检查作业时请务必事先切断电源。
When the motor temperature drops, the thermal protector closes and the motor restarts. Be sure to turn the motor off before inspecting.
- 注：“-A”型号中电压为110V时，配置电容器容量以实际铭牌为准。
Note:“-A” it means the voltage 110V,the assembly capacitor vaule it is according the labe.

■ 种类 Type

- 电动机 Motor

机型 Type	型号 Model	
	齿轮轴型 Pinion Shaft	圆轴型 Round Shaft
导线型 Lead Wire Type	5RK120GU-AFM	5RK120A-AFM
	5RK120GU-EFM	5RK120A-EFM
	5RK120GU-CFM	5RK120A-CFM
	5RK120GU-HFM	5RK120A-HFM
	5RK120GU-SFM	5RK120A-SFM

- 平行轴减速器（另售） Parallel Shaft Gearhead (Sold Separately)

减速器种类 Gearhead Type	减速器型号 Gearhead Model	减速比 Gear Ratio
长寿命●低噪音 Long Life ● Low Noise	5GU□KB	3、3.6、5、6、7.5、9、 12.5、15、18、25、30、 36、50、60、75、90、 100、120、150、180、200
	5GU10XK (中间减速器 Decimal Gearhead)	

- 减速器型号的□中为减速比的数值
Enter the gear ratio in the box (□) within the model name

■ 装有减速器时的容许转矩 Gear Motor-Torque Table

- 减速器另售·中间减速器另售。电动机型号的□中为表示带端子箱型的记号(T)。
Gearhead and mid-gearbox can be sold separately. Enter the code that represents the terminal box type (T) in the box (□) within the model name.
- 减速品型号的□中为减速比的数值。
Enter the gear ratio in the box(□) within the model name.
- □色表示与电动机同一方向运转，其他则为相反方向。
The colored background □ indicates the same rotating direction of the motor while the rotating direction of others are opposite.
- 转速是以电动机的同步转速（50Hz：1500r/min、60Hz：1800r/min）为基准除以减速比而算出来的数值。实际转速将随负载大小变化所示数值减少2%~20%左右。
The speed is calculated by dividing the motor's synchronous speed (50Hz：1500r/min、60Hz：1800r/min) by the gear ratio. The actual speed is 2%~20% less than the displayed value, depending on the size of the load.
- 希望以大于下表的减速比进行进一步减速时，可在电动机与减速机之间安装减速比为10的中间减速机。这时的容许转矩为20N·m。
To reduce the speed beyond the gear ratio in the table, attach a decimal gearhead(gear ratio:10)between the gearhead and motor. In that case, the permissible torque is 20 N·m.

■ 容许力矩单位 Allowance Torque Unit：上段 Upside (N.m) /下段 Belowside (kgf.cm)

类型 Type 电动机/减速机 Motor/Gearhead	减速比 Gear Ratio		3	3.6	5	6	7.5	9	12.5	15	18	25	30	36	50	60	75	90	100	120	150	180	200	
	转速 Speed r/min	50Hz	500	417	300	250	200	166	120	100	83	60	50	41	30	25	20	16	15	12.5	10	8.3	7.5	
		60Hz	600	500	360	300	240	200	144	120	100	72	60	50	36	30	24	20	18	15	12	10	9	
5RK120GU-AFM 5RK120GU-EFM 5RK120GU-CFM 5RK120GU-HFM 5RK120GU-SFM	50Hz	5GU□KB	2.3	2.7	3.8	4.5	5.6	6.8	8.5	10.2	12.2	15.3	18.4	20	20	20	20	20	20	20	20	20	20	20
		5GU□K	23.4	27.5	38.7	45.9	57.1	69.3	86.7	104	124	156	187	200	200	200	200	200	200	200	200	200	200	200
	60Hz	5GU□KB	1.8	2.2	3.0	3.6	4.6	5.5	6.8	8.2	9.8	12.4	14.9	17.8	20	20	20	20	20	20	20	20	20	20
		5GU□K	18.3	22.4	30.6	36.7	46.9	56.1	69.5	83.6	100	126	152	181	200	200	200	200	200	200	200	200	200	200

■ 容许悬挂负载·容许轴向负载 To Allow The Hoisting Of The Load Allow Axial Load

电动机(圆轴型)→272页 Motor(Round Shaft)→P272
减速机→272页 Gearhead→P272

■ 减速机的容许负载惯性惯量 J Permissible Load Inertia J For Gearhead

→272页→P272

■ 启动、制动特性 (参考值) Starting And Brake Characteristics(Reference Values)

- 单相电动机 Single-phase Motor
- 三相电动机 Three-phase Motor

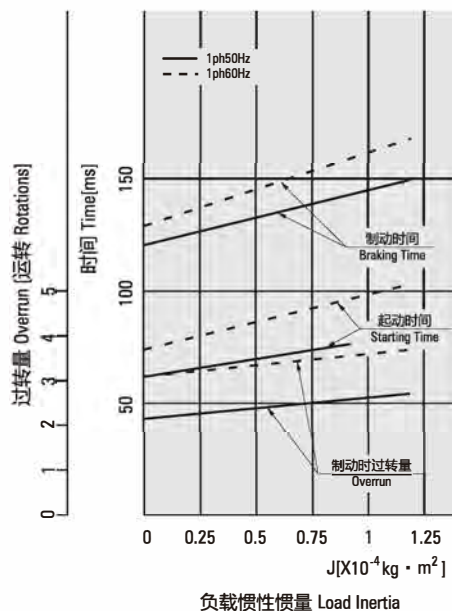
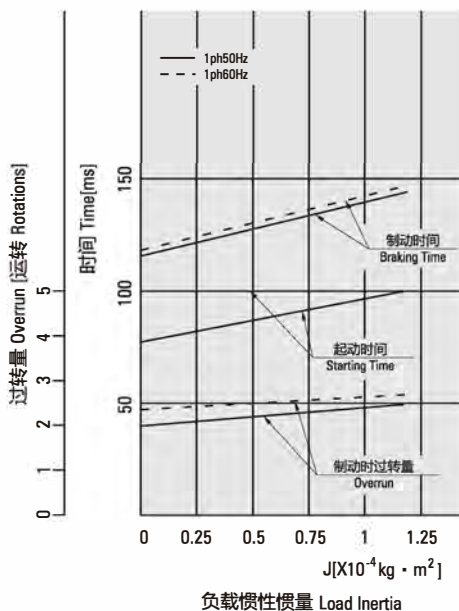

外形图 (单位 mm) Dimensions(Unit mm)

减速器附有安装用螺丝 Mounting screws are included with gearhead.

● 导线型 Lead Wiring Type

重量 Weight : 电动机 Motor : 4.3kg 减速器 Gearhead : 1.5kg

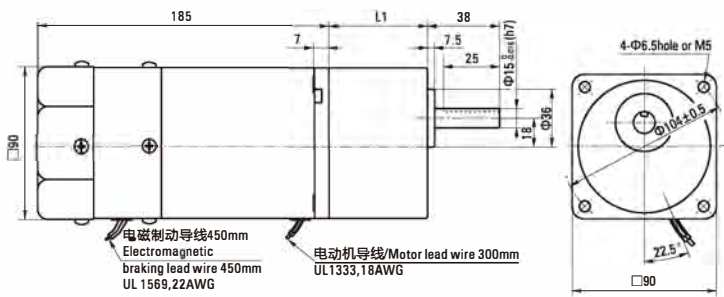

电动机型号 Motor Model	减速器型号 Gearhead Model	减速比 Gear Ratio	L1
5RK120GU-AFM 5RK120GU-EFM 5RK120GU-CFM 5RK120GU-HFM 5RK120GU-SFM	5GU□KB	3~200	65.5

● 减速器型号的□中为减速比的数值
Enter the gear ratio in the box (□) within the model name

● 凸缘安装型减速器 Flange Mounting Reducer

可安装在GU齿轮轴型上
Can be mounted on GU type gear shaft
5GU□K

重量 Weight: 1.5kg

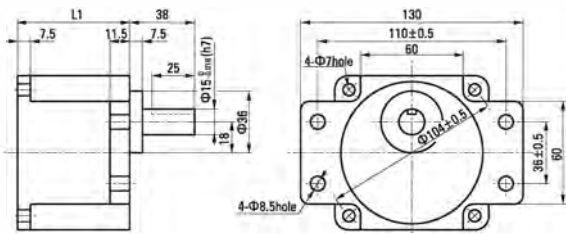

● 键·键槽 (减速器附件)

Key · Keyway (Accessory Of Gearhead)

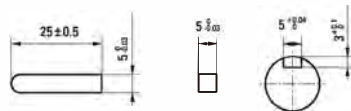

● 圆轴型的转轴部分 Shaft Section Of Round Shaft Type

除重量及轴部外电动机外形与齿轮轴型相同。
Excluding weight and the shaft section motor shape are the same as those of the pinion shaft type.

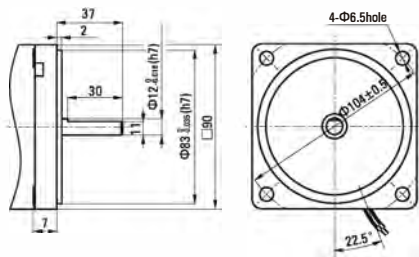

● 中间减速器 Decimal Gearhead

可安装在GU齿轮轴型上 Can be connected to GU pinion shaft type
电动机外形与齿轮轴型相同

5GU10XK
重量 Weight : 0.6kg

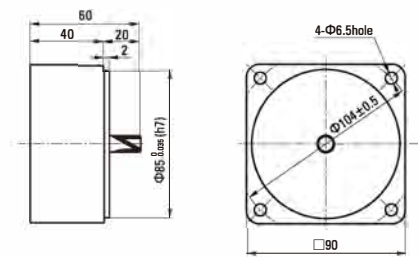

电容器外形尺寸 Formal Dimension Of Capacitor

型号 Model		电容器型号 Capacitor Model	L	W	H
齿轮轴型 Pinion Shaft	圆轴型 Round Shaft				
5RK120GU-AFM	5RK120A-AFM	ZD350CFAUL	58	30	40
5RK120GU-EFM	5RK120A-EFM	ZD300CFAUL	58	26	38
5RK120GU-CFM	5RK120A-CFM	ZD80BFAUL	48	26.5	38

● 常规电容器出线为引线,也可根据客户要求配置插片式187#

Note: Conventional capacitor is a lead wire type. Inserted 187# is optional

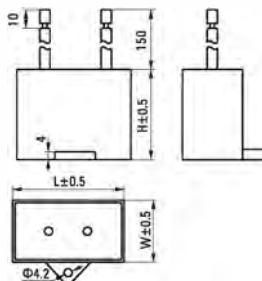

弧锥直角 SPIRAL BEVEL RIGHT ANGLE

■ 装有减速器时的容许转矩 Gear Motor-Torque Table

- 减速器 中间减速器另售。● 电动机型号的□中为表示带端子箱型的记号(T)。
Gearhead and mid-gearbox can be sold separately. Enter the code that represents the terminal box type (T) in the box (□) within the model name.
- 减速器型号中的□中为减速比的数值。□色表示与电动机同一方向运转，其他则为相反方向。
Enter the gear ratio in the box (□) within the model name.
The colored background □ indicates the same rotating direction of the motor while the rotating direction of others are opposite.
- 转速是以电动机的同步转速 (50Hz:1500r/min、60Hz:1800r/min) 为基准除以减速比而算出来的数值。实际转速将随负载大小变化而比所示数值减少2%~20%左右。
The speed is calculated by dividing the motor's synchronous speed (50Hz:1500r/min、60Hz:1800r/min) by the gear ratio. The actual speed is 2%~20% less than the displayed value, depending on the size of the load.
- 希望以大于下表的减速比进行进一步减速时，可在电动机与减速器之间安装减速比为10的中间减速器。这时的容许转矩为20N·m。
To reduce the speed beyond the gear ratio in the table, attach a mid-gearbox (gear ratio:10) between the gearhead and motor. In that case, the permissible torque is 20N·m.

■ 容许力矩单位 Allowance Torque Unit: 上段 Upside (N.m) / 下段 Belowside (kgf.cm)

机型Type 电动机/减速器 Motor/Gearhead	减速比Gear Ratio	容许力矩 Allowance Torque																			
		3	3.6	5	6	7.5	9	12.5	15	18	25	30	3.6	50	60	75	90	100	120	150	180
5RK120GU-AF□M 5RK120GU-EF□M 5RK120GU-CF□M 5RK120GU-HF□M 5RK120GU-SF□M	50Hz	500	417	300	250	200	166	120	100	83	60	50	417	30	25	20	16	15	12	10	8
	60Hz	600	500	360	300	240	200	144	120	100	72	60	500	36	30	24	20	18	15	12	10
5GU□RC 5GU□RT	50Hz	1.70	2.05	2.84	3.41	4.73	5.68	7.89	9.47	11.4	15.8	18.9	20.0	20.0	20.0	20.0	20.0	20.0	20.0	20.0	20.0
	60Hz	1.37	1.65	2.29	2.75	3.82	4.58	6.36	7.64	9.16	12.7	15.3	16.5	20.0	20.0	20.0	20.0	20.0	20.0	20.0	20.0

■ 刹车尺寸图 Brake Type Drawing

5RK120GU-AF□M/5GU□RC 5RK120GU-CF□M/5GU□RC 5RK120GU-EF□M/5GU□RT 5RK120GU-HF□M/5GU□RT 5RK120GU-SF□M/5GU□RC
5RK120GU-AF□M/5GU□RT 5RK120GU-CF□M/5GU□RT 5RK120GU-EF□M/5GU□RT 5RK120GU-HF□M/5GU□RT 5RK120GU-SF□M/5GU□RT

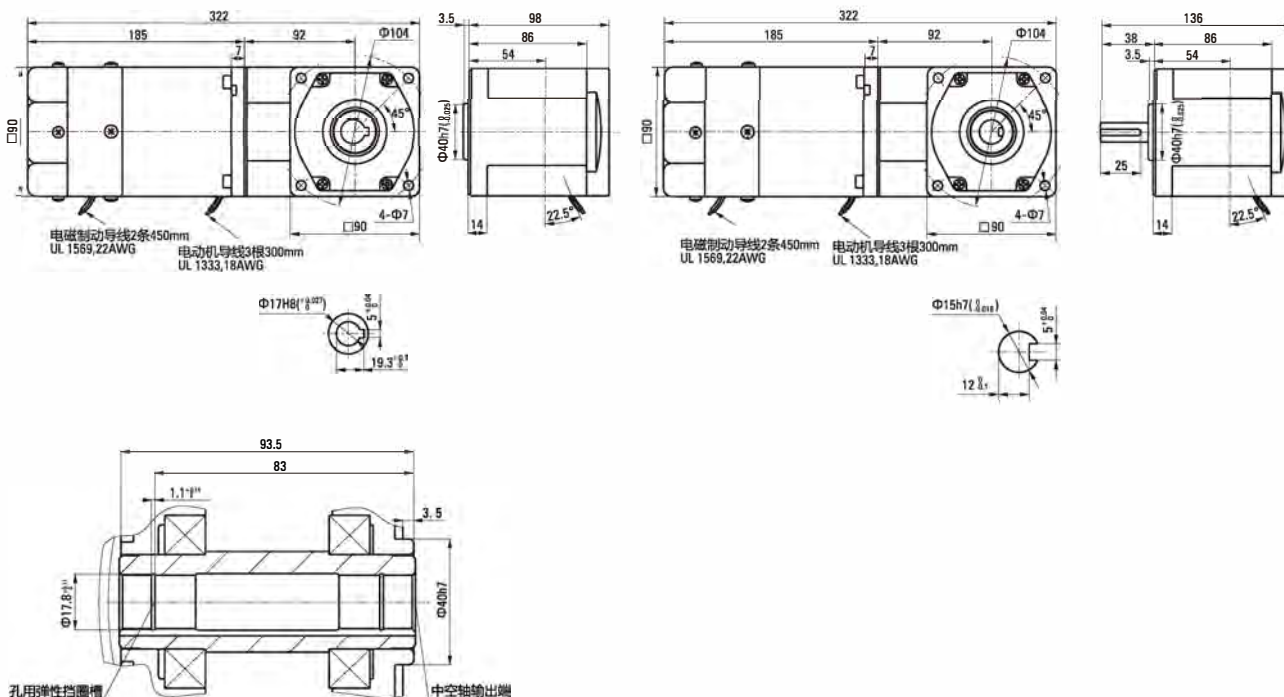

蜗轮蜗杆直角 WORM GEAR RIGHT ANGLE

■ 装有减速器时的容许转矩 Gear Motor-Torque Table

- 减速器-中间减速器另售。● 电动机型号的□中为表示带端子箱型的记号(T)。
Gearhead and mid-gearbox can be sold separately. Enter the code that represents the terminal box type (T) in the box (□) within the model name.
- 减速器型号的□中为减速比的数值。□色表示与电动机同一方向运转，其他则为相反方向。
Enter the gear ratio in the box (□) within the model name.
The colored background □ indicates the same rotating direction of the motor while the rotating direction of others are opposite.
- 转速是以电动机的同步转速 (50Hz:1500r/min、60Hz:1800r/min) 为基准除以减速比而算出来的数值。实际转速将随负载大小变化而比所示数值减少2%~20%左右。
The speed is calculated by dividing the motor's synchronous speed (50Hz:1500r/min、60Hz:1800r/min) by the gear ratio. The actual speed is 2%~20% less than the displayed value, depending on the size of the load.
- 希望以大于下表的减速比进行进一步减速时，可在电动机与减速器之间安装减速比为10的中间减速器。这时的容许转矩为20N·m。
To reduce the speed beyond the gear ratio in the table, attach a mid-gearbox (gear ratio:10) between the gearhead and motor. In that case, the permissible torque is 20N·m.

■ 容许力矩单位 Allowance Torque Unit: 上段 Upside (N.m) / 下段 Belowside (kgf.cm)

机型Type	减速比 Gear Ratio	3	3.6	5	6	7.5	9	12.5	15	18	25	30	3.6	50	60	75	90	100	120	150	180	
电动机/减速器 Motor/Gearhead	转速Speed r/min	50Hz	500	417	300	250	200	166	120	100	83	60	50	417	30	25	20	16	15	12	10	8
	60Hz	600	500	360	300	240	200	144	120	100	72	60	500	36	30	24	20	18	15	12	10	
5RK120GU-AF□□ 5RK120GU-EF□□ 5RK120GU-CF□□ 5RK120GU-HF□□ 5RK120GU-SF□□	容许力矩 Allowance Torque	50Hz	1.24	1.49	1.86	2.23	2.78	3.34	4.64	5.57	6.68	9.28	11.1	13.4	18.6	20.0	20.0	20.0	20.0	20.0	20.0	20.0
		60Hz	1.00	1.20	1.50	1.80	2.25	2.69	3.74	4.49	5.39	7.49	8.98	10.8	15.0	18.0	20.0	20.0	20.0	20.0	20.0	20.0
	5GU□RH 5GU□RA	50Hz	12.6	15.2	18.9	22.7	28.4	34.1	47.4	56.8	68.2	94.7	114	136	189	200	200	200	200	200	200	200
	60Hz	10.18	12.2	15.3	18.3	22.9	27.5	38.2	45.8	55.0	76.4	91.7	110	153	183	200	200	200	200	200	200	

■ 刹车尺寸图 Brake Type Drawing

5RK120GU-AF□□/M/5GU□RH	5RK120GU-CF□□/M/5GU□RH	5RK120GU-AF□□/M/5GU□RA	5RK120GU-CF□□/M/5GU□RA
5RK120GU-EF□□/M/5GU□RH	5RK120GU-HF□□/M/5GU□RH	5RK120GU-EF□□/M/5GU□RA	5RK120GU-HF□□/M/5GU□RA
5RK120GU-SF□□/M/5GU□RH		5RK120GU-SF□□/M/5GU□RA	

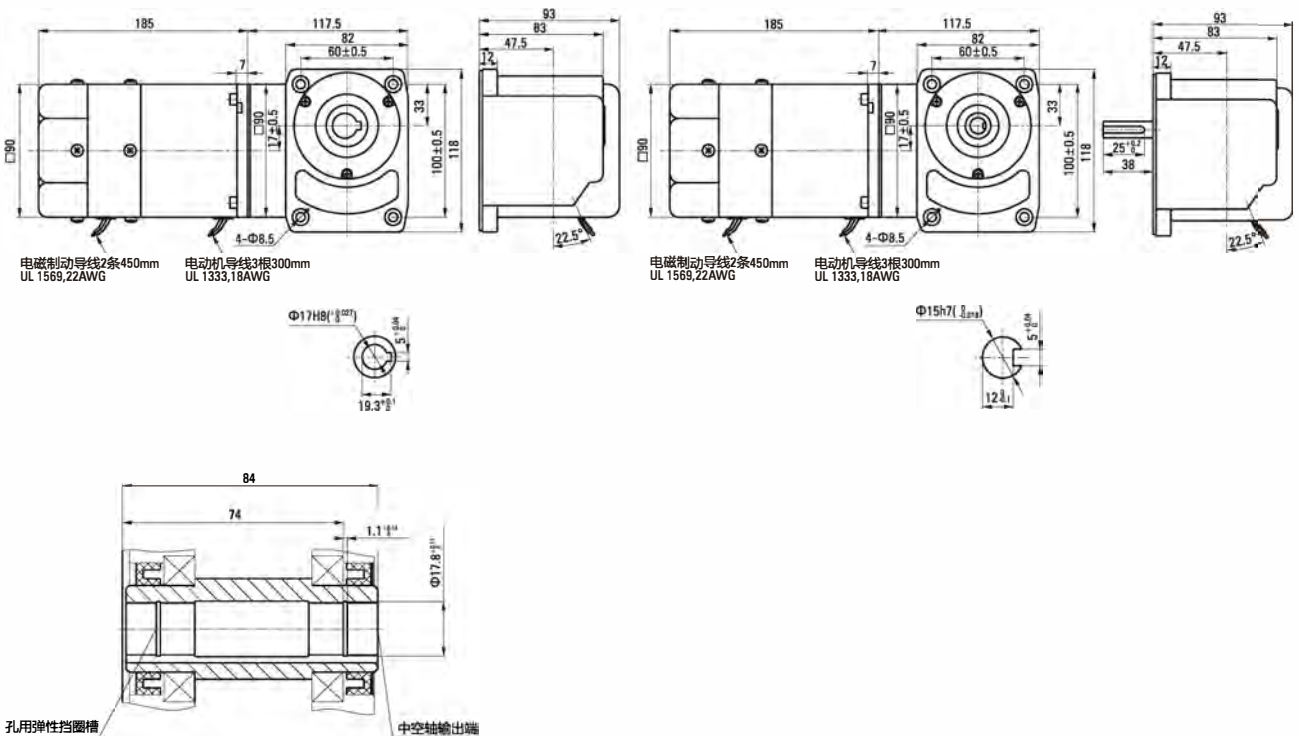

AC交流减速电动机

变频

感应电动机

可逆电动机

刹车电动机

调速电动机

转矩电动机

连接图 Wiring Diagram

- 运转方向指从电动机轴看来的方向。CW表示顺时针方向，CCW表示逆时针方向。

The direction of motor rotation is as viewed from the shaft end of motor. CW represents the clockwise direction, while CCW represents the counterclockwise direction.

- 表中所记品名为齿轮轴型，圆轴型亦同。Name indicated in the list is pinion shaft type, also valid for the equivalent round shaft type.

单相电动机 Single-phase Motor	
5RK120GU-AFM、5RK120GU-EFM、5RK120GU-CFM、5RK120GU-HFM	

SW1为电动机的运行/停止及电磁制动操作作用开关。(连动)

SW1 operates both motor and electromagnetic brake action. (Switched Simultaneously)

SW1设定于ON时，电磁制动解除，电动机开始运行。

The motor will rotate when SW1 is switched simultaneously to ON.

SW1设定于OFF时，电动机停止，电磁制动开始工作。

When SW1 is switched simultaneously to OFF, the motor stops immediately with the electromagnetic brake and holds the load.

在电动机停止状态下解除电磁制动时，应将SW1设定为非连动，而仅将黑色导线侧的触点设定为ON。

If you wish to release the brake while the motor is stopped, set the SW1 to off and connection point at the side of black lead to on.

运转方向。Direction of Rotation.

将SW2转换至CW侧时，电动机作顺时针方向运转。

To rotate the motor in a clockwise (CW) direction, turn SW2 to CW.

将SW2转换至CCW侧时，电动机作逆时针方向运转。

To rotate the motor in a counterclockwise (CCW) direction, turn SW2 to CCW.

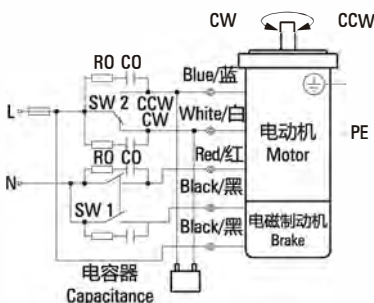

开关 号码 Switch No.	开关的触点容量Capacitor of Switch Connection Point		参考 Note
	单相100V、 110/120V输入 Single-Phase 100 VAC, 110/120 VAC Input	单相220V、 230V输入 Single-Phase 200 VAC, 220/230 VAC Input	
SW1	AC125V 3A以上 (感应负载) 125 VAC 3A minimum (Inductive Load)	AC250V 1.5A以上 (感应负载) 250 VAC 1.5A A minimum (Inductive Load)	连动Switched Simultaneously
SW2			

三相电动机 Three-phase Motor	
5RK120GU-SFM	

SW1为电动机的运行/停止及电磁制动操作作用开关。(连动)

SW1 operates both motor and electromagnetic brake action. (Switched Simultaneously)

SW1设定于ON时，电磁制动解除，电动机开始运行。

The motor will rotate when SW1 is switched simultaneously to ON.

SW1设定于OFF时，电动机停止，电磁制动开始工作。

When SW1 is switched simultaneously to OFF, the motor stops immediately with the electromagnetic brake and holds the load.

在电动机停止状态下解除电磁制动时，应将SW1设定为非连动，而仅将黑色导线侧的触点设定为ON。

If you wish to release the brake while the motor is stopped, set the SW1 to off and connection point at the side of black lead to on.

运转方向。Direction of Rotation.

若对换R、S、T中任意二条，电动机逆时针方向运转。

To change the rotation direction, change any two connections between R, S and T.

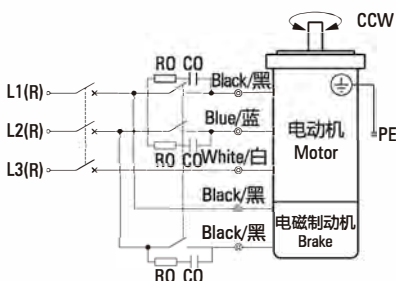

开关 号码 Switch No.	开关的触点容量Capacitor of Switch Connection Point	参考 Note
SW1	AC250V 1.5A以上 (感应负载) 250 VAC 1.5 A minimum (Inductive Load)	连动 Switched Simultaneously

请注意Notes:

- R0C0为吸收电涌电压用CR电路。[R0=5~200Ω、C0=0.1~0.2μF、200WV (400WV)] 请使用选购配件EPCR1201-2。

- R0 and C0 indicate surge suppressor circuit. [R0=5~200Ω, C0=0.1~0.2 μF, 200 WV (400 WV)] EPCR1201-2 is available as an optional surge suppressor.

无励磁动作型电磁制动电动机

POWER OFF ACTIVATED TYPE ELECTROMAGNETIC BRAKE MOTOR

■ 120W □ 104mm



规格 Specs / 电动机 Motor

- 没有内藏简易制动 This type of motor does not contain a built-in simple brake mechanism.

型号 Model · 类型 Type 导线型 Lead Wire Type		额定 Rating	输出功率 Output power W	电压 Voltage V	频率 Frequency Hz	电流 Current A	启动转矩 Starting Torque mN.m	额定转矩 Rated Torque mN.m	额定转速 Rated Speed r/min	电容器容量 Capacitor μF
齿轮轴型 Pinion Shaft	圆轴型 Round Shaft									
6RK120GU-AFM	6RK120A-AFM	30min	120	1ph 100	50	2.1	600	930	1250	35
					60	2.5		750	1550	
6RK120GU-EFM	6RK120A-EFM	30min	120	1ph 110	60	1.70	600	750	1550	30
				1ph 120		1.80				
6RK120GU-CFM	6RK120A-CFM	30min	120	1ph 220	50	0.95	750	930	1250	8.0
				1ph 230						
6RK120GU-HFM	6RK120A-HFM	30min	120	1ph 220	60	0.95	700	750	1550	-
				1ph 230		1.0				
6RK120GU-SFM	6RK120A-SFM	30min	120	3ph 220	50	0.75	2200	890	1250	-
					60	0.70	2000	730	1550	

- 各种安全规格以电动机铭牌上的型号取得认定。

When the motor is approved under various safety standards, the model name on the nameplate is the approved model name.

- (T): 内藏热保护装置 (自动复位型)。在电动机因某种原因过热时会自行起动作使电动机停止。
Contains a built-in thermal protector (automatic return). If a motor overheats for any reason, the thermal protector is opened and the motor stops.
- 电动机温度下降后会自动恢复运行, 故在进行检查作业时请务必事先切断电源。
When the motor temperature drops, the thermal protector closes and the motor restarts. Be sure to turn the motor off before inspecting.
- 注: "-A" 型号中电压为110V时, 配置电容器容量以实际铭牌为准。
Note: "-A" it means the voltage 110V, the assembly capacitor value it is according to the label.

种类 Type

- 电动机 Motor

机型 Type	型号 Model	
	齿轮轴型 Pinion Shaft	圆轴型 Round Shaft
导线型 Lead Wire Type	6RK120GU-AFM	6RK120A-AFM
	6RK120GU-EFM	6RK120A-EFM
	6RK120GU-CFM	6RK120A-CFM
	6RK120GU-HFM	6RK120A-HFM
	6RK120GU-SFM	6RK120A-SFM

- 平行轴减速器 (另售) Parallel Shaft Gearhead (Sold Separately)

减速器种类 Gearhead Type	减速器型号 Gearhead Model	减速比 Gear Ratio
长寿命 ● 低噪音 Long Life ● Low Noise	6GU□K	3、3.6、5、6、7.5、9、 12.5、15、18、25、30、 36、50、60、75、90、 100、120、150、180、200

- 减速器型号的□中为减速比的数值
Enter the gear ratio in the box (□) within the model name

■ 装有减速器时的容许转矩 Gear Motor-Torque Table

- 减速器另售·中间减速器另售。电动机型号的□中为表示带端子箱型的记号(T)。

Gearhead and mid-gearbox can be sold separately. Enter the code that represents the terminal box type (T) in the box (□) within the model name.

- 减速机型号的□中为减速比的数值。

Enter the gear ratio in the box(□) within the model name.

- □色表示与电动机同一方向运转，其他则为相反方向。

The colored background □ indicates the same rotating direction of the motor while the rotating direction of others are opposite.

- 转速是以电动机的同步转速（50Hz：1500r/min、60Hz：1800r/min）为基准除以减速比而算出来的数值。实际转速将随负载大小变化所示数值减少2%~20%左右。

The speed is calculated by dividing the motor's synchronous speed (50Hz：1500r/min、60Hz：1800r/min) by the gear ratio. The actual speed is 2%~20% less than the displayed value, depending on the size of the load.

■ 容许力矩单位 Allowance Torque Unit：上段 Upside (N.m) /下段 Belowside (kgf.cm)

类型 Type 电动机/减速机 Motor/Gearhead	减速比 Gear Ratio		3	3.6	5	6	7.5	9	12.5	15	18	25	30	36	50	60	75	90	100	120	150	180	200	
	转速 Speed r/min	50Hz	500	417	300	250	200	166	120	100	83	60	50	41	30	25	20	16	15	12.5	10	8.3	7.5	
6RK120GU-AFM 6RK120GU-CFM 6RK120GU-SFM	6GU□K	50Hz	2.3	2.7	3.8	4.5	5.6	6.8	8.5	10.2	12.2	15.3	18.4	22.1	30.7	36.8	40	40	40	40	40	40	40	40
			23.4	27.5	38.7	45.9	57.1	69.3	86.7	104	124	156	187	225	313	375	400	400	400	400	400	400	400	400
			2.22	2.6	3.6	4.3	5.4	6.5	8.1	9.7	11.7	14.7	17.6	21.1	29.4	35.2	40	40	40	40	40	40	40	40
			2.4	26.5	36.7	43.8	55.0	66.3	87.6	98.8	119	149	179	215	300	359	400	400	400	400	400	400	400	400

■ 容许力矩单位 Allowance Torque Unit：上段 Upside (N.m) /下段 Belowside (kgf.cm)

类型 Type 电动机/减速机 Motor/Gearhead	减速比 Gear Ratio		3	3.6	5	6	7.5	9	12.5	15	18	25	30	36	50	60	75	90	100	120	150	180	200
	转速 Speed r/min	60Hz	600	500	360	300	240	200	144	120	100	72	60	50	36	30	24	20	18	15	12	10	9
6RK120GU-AFM 6RK120GU-CFM 6RK120GU-HFM 6RK120GU-SFM	6GU□K	50Hz	1.8	2.2	3.0	3.6	4.6	5.5	6.8	8.2	9.8	12.4	14.9	17.8	24.8	29.7	37.1	40	40	40	40	40	40
			18.3	22.4	30.6	36.7	46.9	56.1	69.3	83.6	100	126	152	181	253	303	378	400	400	400	400	400	400
		60Hz	1.8	2.1	3.0	3.5	4.4	5.3	6.7	8.0	9.6	12.0	14.5	17.3	24.1	28.9	36.1	40	40	40	40	40	40
			18.3	21.4	30.6	35.7	44.8	54.0	68.3	81.6	97.9	122	148	176	245	295	368	400	400	400	400	400	400

■ 容许悬挂负载·容许轴向负载 To Allow The Hoisting Of The Load Allow Axial Load

电动机(圆轴型)→272页

Motor(Round Shaft)→P272

减速机→272页

Gearhead→P272

■ 减速机的容许负载惯性惯量 J Permissible Load Inertia J For Gearhead

→272页→P272

■ 起动、制动特性 (参考值) Starting And Brake Characteristics(Reference Values)

● 单相电动机 Single-phase Motor

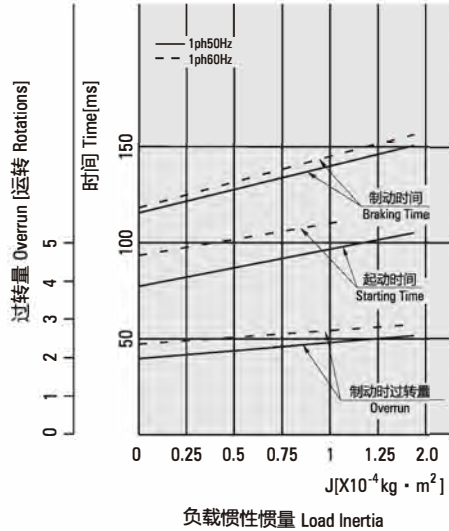

● 三相电动机 Three-phase Motor

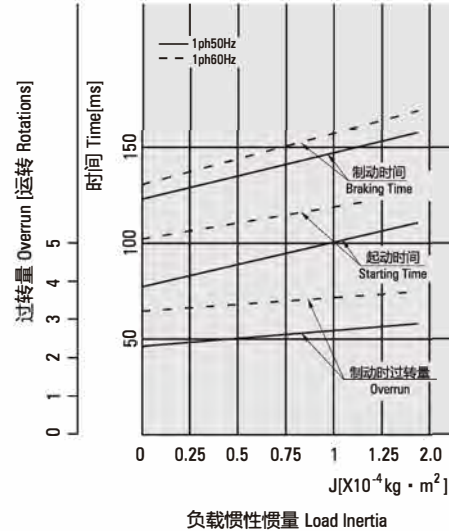

■ 外形图 (单位 mm) Dimensions(Unit mm)

减速器附有安装用螺丝 Mounting screws are included with gearhead.

● 导线型 Lead Wiring Type 重量 Weight : 电动机 Motor : 5.65kg

减速器 Gearhead : 2.1kg

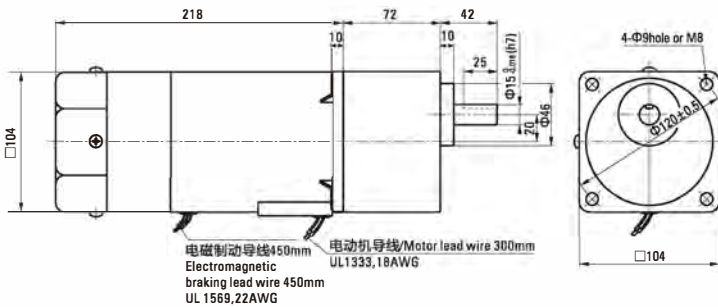

电动机型号 Motor Model	减速器型号 Gearhead Model	减速比 Gear Ratio	L1
6RK120GU-AFM 6RK120GU-EFM 6RK120GU-CFM 6RK120GU-HFM 6RK120GU-SFM	6GU□K	3~200	72

● 减速器型号的□中为减速比的数值
Enter the gear ratio in the box (□) within the model name

● 圆轴型的转轴部分 Shaft Section Of Round Shaft Type

除重量及轴部外电动机外形与齿轮轴型相同。
Excluding weight and the shaft section motor shape are the same as those of the pinion shaft type.

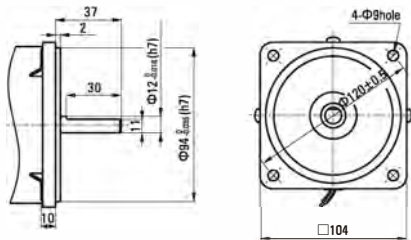

● 键·键槽 (减速器附件)

Key · Keyway(Accessory Of Gearhead)

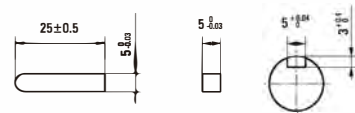

■ 电容器外形尺寸 Formal Dimension Of Capacitor

型号 Model		电容器型号 Capacitor Model	L	W	H
齿轮轴型 Pinion Shaft	圆轴型 Round Shaft				
6RK120GU-AFM	6RK120A-AFM	ZD350CFAUL	58	26	38
6RK120GU-EFM	6RK120A-EFM	ZD250CFAUL	47	23	35
6RK120GU-CFM	6RK120A-CFM	ZD80BFAUL	48	26.5	38

● 常规电容器出线为引线,也可根据客户要求配置插片式187#

Note: Conventional capacitor is a lead wire type. Inserted 187# is optional

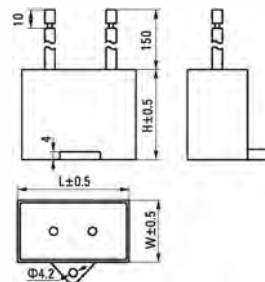

弧锥直角 SPIRAL BEVEL RIGHT ANGLE

■ 装有减速器时的容许转矩 Gear Motor-Torque Table

- 减速器·中间减速器另售。● 电动机型号的□中为表示带端子箱型的记号(T)。
Gearhead and mid-gearbox can be sold separately. Enter the code that represents the terminal box type (T) in the box (□) within the model name.
- 减速器型号的□中为减速比的数值。□色表示与电动机同一方向运转，其他则为相反方向。
Enter the gear ratio in the box (□) within the model name.
The colored background □ indicates the same rotating direction of the motor while the rotating direction of others are opposite.
- 转速是以电动机的同步转速 (50Hz:1500r/min、60Hz:1800r/min) 为基准除以减速比而算出来的数值。实际转速将随负载大小变化而比所示数值减少2%~20%左右。
The speed is calculated by dividing the motor's synchronous speed (50Hz:1500r/min、60Hz:1800r/min) by the gear ratio. The actual speed is 2%~20% less than the displayed value, depending on the size of the load.
- 希望以大于下表的减速比进行进一步减速时，可在电动机与减速器之间安装减速比为10的中间减速器。这时的容许转矩为60N·m。
To reduce the speed beyond the gear ratio in the table, attach a mid-gearbox (gear ratio:10) between the gearhead and motor. In that case, the permissible torque is 60N·m.

■ 容许力矩单位 Allowance Torque Unit: 上段 Upside (N.m) / 下段 Belowside (kgf.cm)

机型Type 电动机/减速器 Motor/Gearhead	减速比Gear Ratio	容许力矩 Allowance Torque																				
		3	3.6	5	6	7.5	9	12.5	15	18	25	30	3.6	50	60	75	90	100	120	150	180	
电动机/减速器 Motor/Gearhead	转速Speed r/min	50Hz	500	417	300	250	200	166	120	100	83	60	50	417	30	25	20	16	15	12	10	8
	60Hz	600	500	360	300	240	200	144	120	100	72	60	500	36	30	24	20	18	15	12	10	10
6RK120GU-AF□M 6RK120GU-EF□M 6RK120GU-CF□M 6RK120GU-HF□M 6RK120GU-SF□M	容许力矩 Allowance Torque	50Hz	1.70	2.05	2.84	3.41	4.26	5.68	7.89	9.47	11.4	15.8	18.9	22.7	28.4	34.1	42.6	51.1	56.8	60.0	60.0	60.0
			17.4	20.9	29.0	34.8	43.5	58.0	80.5	96.6	116	161	193	232	290	348	435	522	580	600	600	600
		60Hz	1.37	1.65	2.29	2.75	3.44	4.58	6.36	7.64	9.16	12.7	15.3	18.3	22.9	27.5	34.4	41.2	45.8	55.0	60.0	60.0
			14.0	16.8	23.4	28.0	35.1	46.7	64.9	77.9	93.5	130	156	187	234	280	351	421	467	561	600	600

■ 刹车尺寸图 Brake Type Drawing

6RK120GU-AF□M/6GU□RC 6RK120GU-CF□M/6GU□RC 6RK120GU-EF□M/6GU□RC 6RK120GU-HF□M/6GU□RC 6RK120GU-SF□M/6GU□RC
 6RK120GU-AF□M/6GU□RT 6RK120GU-CF□M/6GU□RT 6RK120GU-EF□M/6GU□RT 6RK120GU-HF□M/6GU□RT 6RK120GU-SF□M/6GU□RT

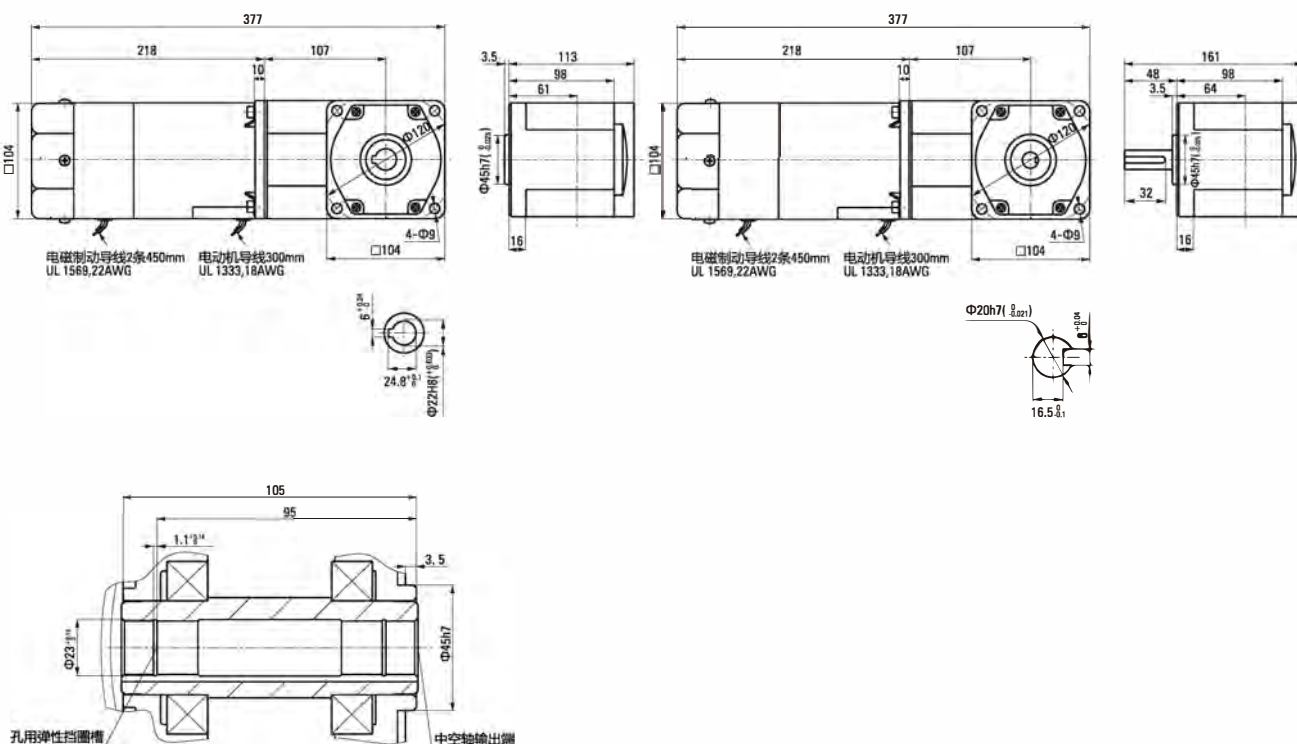

连接图 Wiring Diagram

- 运转方向指从电动机轴看来的方向。CW表示顺时针方向，CCW表示逆时针方向。

The direction of motor rotation is as viewed from the shaft end of motor. CW represents the clockwise direction, while CCW represents the counterclockwise direction.

- 表中所记品名为齿轮轴型，圆轴型亦同。Name indicated in the list is pinion shaft type, also valid for the equivalent round shaft type.

单相电动机 Single-phase Motor	
6RK120GU-AFM、6RK120GU-EFM、6RK120GU-CFM、6RK120GU-HFM	

SW1为电动机的运行/停止及电磁制动操作作用开关。（连动）

SW1 operates both motor and electromagetic brake action. (Switched Simultaneously)

SW1设定于ON时，电磁制动解除，电动机开始运行。

The motor will rotate when SW1 is switched simultaneously to ON.

SW1设定于OFF时，电动机停止，电磁制动开始工作。

When SW1 is switched simultaneously to OFF, the motor stops immediately with the electromagetic brake and holds the load.

在电动机停止状态下解除电磁制动时，应将SW1设定为非连动，而仅将黑色导线侧的触点设定为ON。

If you wish to release the brake while the motor is stopped, set the SW1 to off and connection point at the side of black lead to on.

运转方向。Direction of Rotation.

将SW2转换至CW侧时，电动机作顺时针方向运转。

To rotate the motor in a clockwise (CW) direction, turn SW2 to CW.

将SW2转换至CCW侧时，电动机作逆时针方向运转。

To rotate the motor in a counterclockwise (CCW) direction, turn SW2 to CCW.

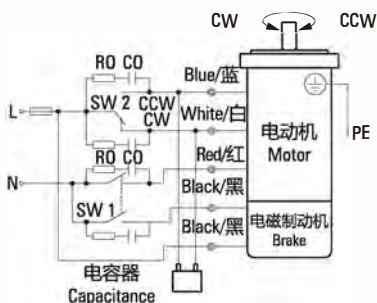

开关 号码 Switch No.	开关的触点容量Capacitor of Switch Connection Point		参考 Note
	单相100V、 110/120V输入 Single-Phase 100 VAC, 110/120 VAC Input	单相220V、 230V输入 Single-Phase 200 VAC, 220/230 VAC Input	
SW1	AC125V 8A以上 (感应负载) 125 VAC 8A minimum (Inductive Load)	AC250V 8A以上 (感应负载) 250 VAC 8A A minimum (Inductive Load)	连动Switched Simultaneously
SW2			-

三相电动机 Three-phase Motor	
6RK120GU-SFM	

SW1为电动机的运行/停止及电磁制动操作作用开关。（连动）

SW1 operates both motor and electromagetic brake action. (Switched Simultaneously)

SW1设定于ON时，电磁制动解除，电动机开始运行。

The motor will rotate when SW1 is switched simultaneously to ON.

SW1设定于OFF时，电动机停止，电磁制动开始工作。

When SW1 is switched simultaneously to OFF, the motor stops immediately with the electromagetic brake and holds the load.

在电动机停止状态下解除电磁制动时，应将SW1设定为非连动，而仅将黑色导线侧的触点设定为ON。

If you wish to release the brake while the motor is stopped, set the SW1 to off and connection point at the side of black lead to on.

运转方向。Direction of Rotation.

若对换R、S、T中任意二条，电动机作逆时针方向运转。

To change the rotation direction, change any two connections between R, S and T.

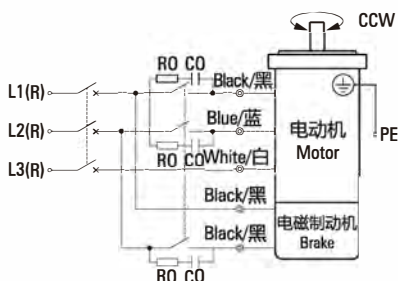

开关 号码 Switch No.	开关的触点容量Capacitor of Switch Connection Point		参考 Note
SW1	AC250V 1.5A以上 (感应负载) 250 VAC 1.5 A minimum (Inductive Load)		连动 Switched Simultaneously

请注意Notes:

- ROCO为吸收电涌电压用CR电路。[R0=5~200Ω、C0=0.1~0.2μF、200WV (400WV)] 请使用选购配件EPCR1201-2。

- R0 and C0 indicate surge suppressor circuit. [R0=5~200Ω, C0=0.1~0.2 μF, 200 WV (400 WV)] EPCR1201-2 is available as an optional surge suppressor.

无励磁动作型电磁制动电动机 POWER OFF ACTIVATED TYPE ELECTROMAGNETIC BRAKE MOTOR

■ 140W □ 104mm



规格 Specs / 电动机 Motor

● 没有内藏简易制动 This type of motor does not contain a built-in simple brake mechanism.

型号Model · 类型 Type 导线型 Lead Wire Type		额定 Rating	输出功率 Output power W	电压 Voltage V	频率 Frequency Hz	电流 Current A	启动转矩 Starting Torque mN.m	额定转矩 Rated Torque mN.m	额定转速 Rated Speed r/min	电容器容量 Capacitor μF
齿轮轴型 Pinion Shaft	圆轴型 Round Shaft									
6RK140GU-AFM	6RK140A-AFM	30min	140	1ph 100	50	2.7	700	1080	1250	35
					60	3.0		870	1550	
6RK140GU-EFM	6RK140A-EFM	30min	140	1ph 110	60	1.80	700	850	1550	25
				1ph 120		1.95				
6RK140GU-CFM	6RK140A-CFM	30min	140	1ph 220	50	1.05	850	1040	1250	10
				1ph 230		1.15				
6RK140GU-HFM	6RK140A-HFM	30min	140	1ph 220	60	1.05	750	850	1550	-
				1ph 230		1.15				
6RK140GU-SM	6RK140A-SM	30min	140	3ph 220	50	0.85	2700	1080	1250	-
					60	0.75	2200	870	1550	

● 各种安全规格以电动机铭牌上的型号取得认定。

When the motor is approved under various safety standards, the model name on the nameplate is the approved model name.

● (T): 内藏热保护装置 (自动复位型)。在电动机因某种原因过热时会自行启动使电动机停止。

Contains a built-in thermal protector(automatic return). If a motor overheats for any reason, the thermal protector is opened and the motor stops.

● 电动机温度下降后会自行恢复运行，故在进行检查作业时请务必事先切断电源。

When the motor temperature drops, the thermal protector closes and the motor restarts. Be sure to turn the motor off before inspecting.

● 注：“-A”型号中电压为110V时，配置电容器容量以实际铭牌为准。

Note:“-A” it means the voltage 110v,the assembly capacitor vaule it is according the labe.

种类 Type

● 电动机 Motor

机型 Type	型号Model	
	齿轮轴型 Pinion Shaft	圆轴型 Round Shaft
导线型 Lead Wire Type	6RK140GU-AFM	6RK140A-AFM
	6RK140GU-EFM	6RK140A-EFM
	6RK140GU-CFM	6RK140A-CFM
	6RK140GU-HFM	6RK140A-HFM
	6RK140GU-SFM	6RK140A-SFM

● 平行轴减速器 (另售) Parallel Shaft Gearhead (Sold Separately)

减速器种类 Gearhead Type	减速器型号 Gearhead Model	减速比 Gear Ratio
长寿命●低噪音 Long Life ● Low Noise	6GU□K	3、3.6、5、6、7.5、9、 12.5、15、18、25、30、 36、50、60、75、90、 100、120、150、180、200

● 减速器型号的□中为减速比的数值

Enter the gear ratio in the box (□) within the model name

■ 装有减速器时的容许转矩 Gear Motor-Torque Table

- 减速器另售·中间减速器另售。电动机型号的□中为表示带端子箱型的记号(T)。
Gearhead and mid-gearbox can be sold separately. Enter the code that represents the terminal box type (T) in the box (□) within the model name.
- 减速品型号的□中为减速比的数值。
Enter the gear ratio in the box(□) within the model name.
- □色表示与电动机同一方向运转，其他则为相反方向。
The colored background □ indicates the same rotating direction of the motor while the rotating direction of others are opposite.
- 转速是以电动机的同步转速（50Hz：1500r/min、60Hz：1800r/min）为基准除以减速比而算出来的数值。实际转速将随负载大小变化所示数值减少2%~20%左右。
The speed is calculated by dividing the motor's synchronous speed (50Hz：1500r/min、60Hz：1800r/min) by the gear ratio. The actual speed is 2%~20% less than the displayed value, depending on the size of the load.

■ 容许力矩单位 Allowance Torque Unit：上段 Upside (N.m) /下段 Belowside (kgf.cm)

类型 Type 电动机/减速机 Motor/Gearhead	减速比 Gear Ratio		3	3.6	5	6	7.5	9	12.5	15	18	25	30	36	50	60	75	90	100	120	150	180	200		
	转速 Speed r/min	50Hz 60Hz	500	417	300	250	200	166	120	100	83	60	50	41	30	25	20	16	15	12.5	10	8.3	7.5		
6RK140GU-AFM 6RK140GU-SFM 6RK140GU-CFM	6GU□K	50Hz	2.6	3.1	4.4	5.2	6.6	7.9	9.9	11.8	14.2	17.8	21.4	25.7	35.6	40	40	40	40	40	40	40	40	40	
			26.5	31.6	44.8	53.0	67.3	80.6	101	120	144	181	218	262	263	400	400	400	400	400	400	400	400	400	400
			2.5	3.0	4.2	5.1	6.3	7.6	9.5	11.4	13.7	17.2	20.6	24.7	34.3	40	40	40	40	40	40	40	40	40	40
			25.5	30.6	42.8	52.0	63.2	77.5	96.9	116	139	175	210	252	349	400	400	400	400	400	400	400	400	400	400

■ 容许力矩单位 Allowance Torque Unit：上段 Upside (N.m) /下段 Belowside (kgf.cm)

类型 Type 电动机/减速机 Motor/Gearhead	减速比 Gear Ratio		3	3.6	5	6	7.5	9	12.5	15	18	25	30	36	50	60	75	90	100	120	150	180	200		
	转速 Speed r/min	50Hz 60Hz	600	500	360	300	240	200	144	120	100	72	60	50	36	30	24	20	18	15	12	10	9		
6RK140GU-AFM 6RK140GU-HFM 6RK140GU-SFM 6RK140GU-EFM	6GU□K	50Hz	2.1	2.5	3.5	4.2	5.3	6.3	7.9	9.5	11.4	14.4	17.2	20.7	28.7	34.5	40	40	40	40	40	40	40	40	
			21.4	25.5	35.7	42.8	54.0	64.2	80.6	96.9	116	147	175	211	292	352	400	400	400	400	400	400	400	400	400
		60Hz	2.1	2.5	3.4	4.1	5.2	6.2	7.8	9.3	11.2	14.0	16.8	20.2	28.0	33.7	40	40	40	40	40	40	40	40	40
			21.4	25.5	34.6	41.8	53.0	63.2	79.5	94.8	114	142	171	206	285	343	400	400	400	400	400	400	400	400	400

■ 容许悬挂负载·容许轴向负载 To Allow The Hoisting Of The Load Allow Axial Load

电动机 (圆轴型) →272页 Motor(Round Shaft) →P272
 减速机→272页 Gearhead→P272

■ 减速机的容许负载惯性惯量 J Permissible Load Inertia J For Gear head

→272页→P272

■ 启动、制动特性 (参考值) Starting And Brake Characteristics(Reference Values)

● 单相电动机 Single-phase Motor

● 三相电动机 Three-phase Motor

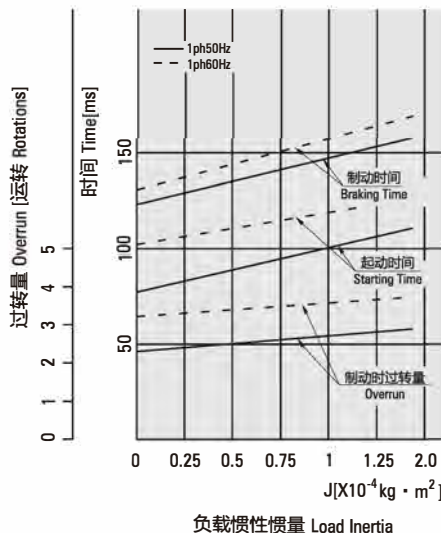
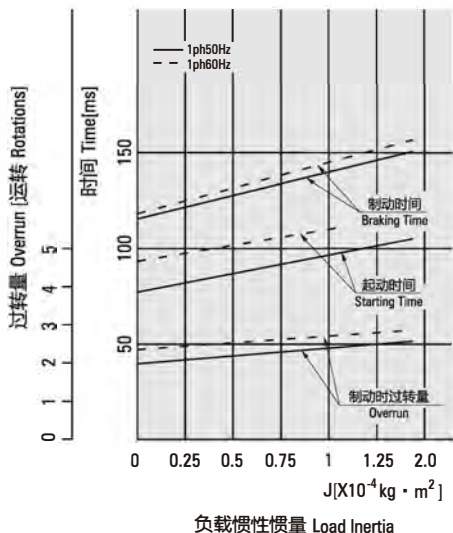

外形图 (单位 mm) Dimensions(Unit mm)

减速器附有安装用螺丝 Mounting screws are included with gearhead.

● 导线型 Lead Wiring Type

重量 Weight : 电动机 Motor : 5.85kg 减速器 Gearhead : 2.1kg

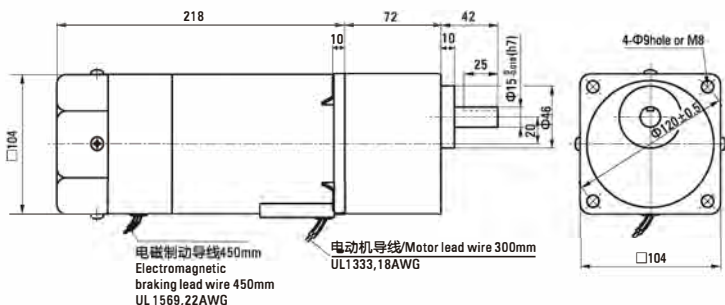

电动机型号 Motor Model	减速器型号 Gearhead Model	减速比 Gear Ratio	L1
6RK140GU-AFM	6GU□K	3~200	72
6RK140GU-EFM			
6RK140GU-CFM			
6RK140GU-HFM			
6RK140GU-SFM			

● 减速器型号的□中为减速比的数值
Enter the gear ratio in the box (□) within the model name

● 圆轴型的转轴部分 Shaft Section of Round Shaft Type

除重量及轴部外电动机外形与齿轮轴型相同。
Excluding weight and the shaft section motor shape are the same as those of the pinion shaft type.

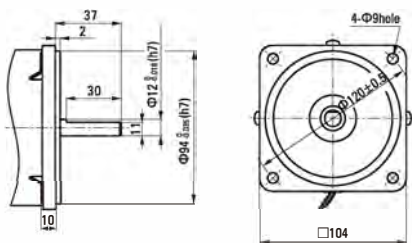

● 键·键槽 (减速器附件)

Key · Keyway(Accessory Of Gearhead)

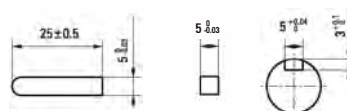

电容器外形尺寸 Formal Dimension of Capacitor

型号Model		电容器型号 Capacitor Model	L	W	H
齿轮轴型 Pinion Shaft	圆轴型 Round Shaft				
6RK140GU-AFM	6RK140A-AFM	ZD400CFAUL	58	30	40
6RK140GU-EFM	6RK140A-EFM	ZD300CFAUL	47	27	37
6RK140GU-CFM	6RK140A-CFM	ZD100BFAUL	58	26	38

● 常规电容器出线为引线,也可根据客户要求配置插片式187#

Note: Conventional capacitor is a lead wire type. Inserted 187# is optional

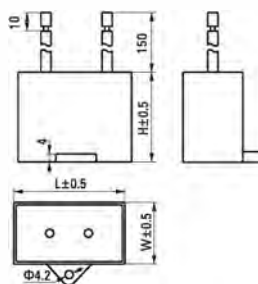

弧锥直角 SPIRAL BEVEL RIGHT ANGLE

■ 装有减速器时的容许转矩 Gear Motor-Torque Table

- 减速器-中间减速器另售。● 电动机型号的□中为表示带端子箱型的记号(T)。
Gearhead and mid-gearbox can be sold separately. Enter the code that represents the terminal box type (T) in the box (□) within the model name.
- 减速器型号的□中为减速比的数值。□色表示与电动机同一方向运转，其他则为相反方向。
Enter the gear ratio in the box (□) within the model name.
The colored background □ indicates the same rotating direction of the motor while the rotating direction of others are opposite.
- 转速是以电动机的同步转速 (50Hz:1500r/min、60Hz:1800r/min) 为基准除以减速比而算出来的数值。实际转速将随负载大小变化而比所示数值减少2%~20%左右。
The speed is calculated by dividing the motor's synchronous speed (50Hz:1500r/min、60Hz:1800r/min) by the gear ratio. The actual speed is 2%~20% less than the displayed value, depending on the size of the load.
- 希望以大于下表的减速比进行进一步减速时，可在电动机与减速器之间安装减速比为10的中间减速器。这时的容许转矩为60N·m。
To reduce the speed beyond the gear ratio in the table, attach a mid-gearbox (gear ratio:10) between the gearhead and motor. In that case, the permissible torque is 60N·m.

■ 容许力矩单位 Allowance Torque Unit: 上段 Upside (N.m) / 下段 Belowside (kgf.cm)

机型Type	减速比Gear Ratio	3	3.6	5	6	7.5	9	12.5	15	18	25	30	3.6	50	60	75	90	100	120	150	180		
电动机/减速器 Motor/Gearhead	转速Speed r/min	50Hz	500	417	300	250	200	166	120	100	83	60	50	417	30	25	20	16	15	12	10	8	
	60Hz	600	500	360	300	240	200	144	120	100	72	60	500	36	30	24	20	18	15	12	10		
6RK140GU-AF□M 6RK140GU-EF□M 6RK140GU-CF□M 6RK140GU-HF□M 6RK140GU-SF□M	6GU□RC 6GU□RT	容许力矩 Allowance Torque	50Hz	1.99	2.39	3.31	3.98	4.97	6.63	9.21	11.0	13.3	18.4	22.1	26.5	33.1	39.8	49.7	59.6	60.0	60.0	60.0	60.0
			60Hz	1.60	1.92	2.67	3.21	4.01	5.34	7.42	8.91	10.7	14.8	17.8	21.4	26.7	32.1	40.1	48.1	53.4	60.0	60.0	60.0
		50Hz	20.3	24.3	33.8	40.6	50.7	67.6	93.9	113	135	188	225	271	338	406	507	600	600	600	600	600	600
		60Hz	16.4	19.6	27.3	32.7	40.9	54.5	75.8	90.9	109	152	182	218	273	327	409	491	545	600	600	600	600

■ 刹车尺寸图 Brake Type Drawing

6RK140GU-AF□M/6GU□RC	6RK140GU-CF□M/6GU□RC	6RK140GU-EF□M/6GU□RC	6RK140GU-HF□M/6GU□RC	6RK140GU-SF□M/6GU□RC	6RK140GU-AF□M/6GU□RT	6RK140GU-CF□M/6GU□RT	6RK140GU-EF□M/6GU□RT	6RK140GU-HF□M/6GU□RT	6RK140GU-SF□M/6GU□RT
----------------------	----------------------	----------------------	----------------------	----------------------	----------------------	----------------------	----------------------	----------------------	----------------------

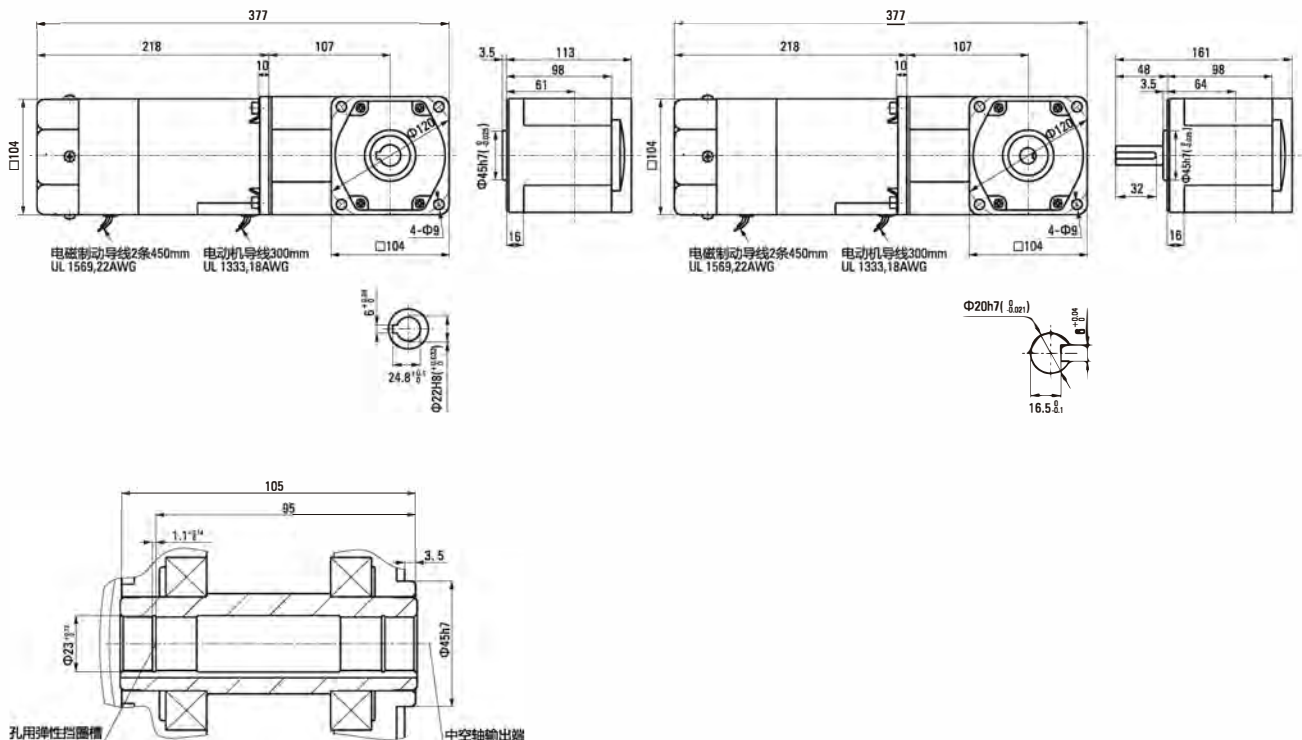

连接图 Wiring Diagram

●运转方向指从电动机轴看来的方向。CW表示顺时针方向，CCW表示逆时针方向。

The direction of motor rotation is as viewed from the shaft end of motor. CW represents the clockwise direction, while CCW represents the counterclockwise direction.

●表中所记品名为齿轮轴型，圆轴型亦同。Name indicated in the list is pinion shaft type, also valid for the equivalent round shaft type.

单相电动机 Single-phase Motor	
6RK140GU-AFM、6RK140GU-EFM、6RK140GU-CFM、6RK140GU-HFM	

SW1为电动机的运行/停止及电磁制动操作作用开关。(连动)

SW1 operates both motor and electromagnetic brake action. (Switched Simultaneously)

SW1设定于ON时，电磁制动解除，电动机开始运行。

The motor will rotate when SW1 is switched simultaneously to ON.

SW1设定于OFF时，电动机停止，电磁制动开始工作。

When SW1 is switched simultaneously to OFF, the motor stops immediately with the electromagnetic brake and holds the load.

在电动机停止状态下解除电磁制动时，应将SW1设定为非连动，而仅将黑色导线侧的触点设定为ON。

If you wish to release the brake while the motor is stopped, set the SW1 to off and connection point at the side of black lead to on.

运转方向。Direction of Rotation.

将SW2转换至CW侧时，电动机作顺时针方向运转。

To rotate the motor in a clockwise (CW) direction, turn SW2 to CW.

将SW2转换至CCW侧时，电动机作逆时针方向运转。

To rotate the motor in a counterclockwise (CCW) direction, turn SW2 to CCW.

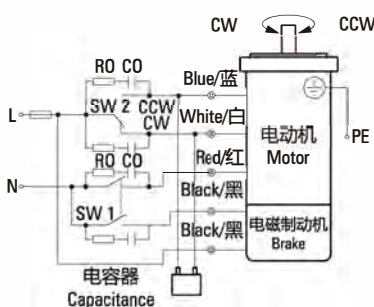

开关 号码 Switch No.	开关的触点容量Capacitor of Switch Connection Point		参考 Note
	单相100V、 110/120V输入 Single-Phase 100 VAC, 110/120 VAC Input	单相220V、 230V输入 Single-Phase 200 VAC, 220/230 VAC Input	
SW1	AC125V 8A以上 (感应负载) 125 VAC 8A minimum (Inductive Load)	AC250V 8A以上 (感应负载) 250 VAC 8A A minimum (Inductive Load)	连动Switched Simultaneously
SW2			

三相电动机 Three-phase Motor	
6RK140GU-SFM	

SW1为电动机的运行/停止及电磁制动操作作用开关。(连动)

SW1 operates both motor and electromagnetic brake action. (Switched Simultaneously)

SW1设定于ON时，电磁制动解除，电动机开始运行。

The motor will rotate when SW1 is switched simultaneously to ON.

SW1设定于OFF时，电动机停止，电磁制动开始工作。

When SW1 is switched simultaneously to OFF, the motor stops immediately with the electromagnetic brake and holds the load.

在电动机停止状态下解除电磁制动时，应将SW1设定为非连动，而仅将黑色导线侧的触点设定为ON。

If you wish to release the brake while the motor is stopped, set the SW1 to off and connection point at the side of black lead to on.

运转方向。Direction of Rotation.

若对换R、S、T中任意二条，电动机作逆时针方向运转。

To change the rotation direction, change any two connections between R, S and T.

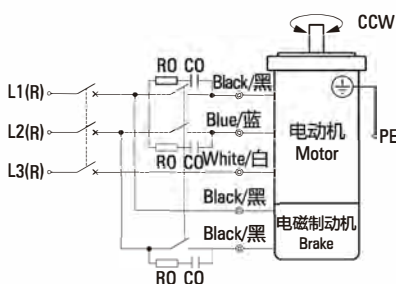

开关 号码 Switch No.	开关的触点容量Capacitor of Switch Connection Point		参考 Note
SW1	AC250V 1.5A以上 (感应负载) 250 VAC 1.5 A minimum (Inductive Load)		连动 Switched Simultaneously

请注意Notes:

●ROCO为吸收电涌电压用CR电路。[R0=5~200Ω、C0=0.1~0.2μF、200WV (400WV)] 请使用选购配件EPCR1201-2。

●R0 and C0 indicate surge suppressor circuit. [R0=5~200Ω, C0=0.1~0.2 μ F, 200 WV (400 WV)] EPCR1201-2 is available as an optional surge suppressor.

无励磁动作型电磁制动电动机

POWER OFF ACTIVATED TYPE ELECTROMAGNETIC BRAKE MOTOR

■ 200W □ 104mm



规格 Specs / 电动机 Motor

- 没有内藏简易制动 This type of motor does not contain a built-in simple brake mechanism.

型号Model · 类型 Type 导线型 Lead Wire Type		额定 Rating	输出功率 Output power	电压 Voltage	频率 Frequency	电流 Current	启动转矩 Starting Torque	额定转矩 Rated Torque	额定转速 Rated Speed	电容器容量 Capacitor
齿轮轴型 Pinion Shaft	圆轴型 Round Shaft									
6RK200GU-AFM	6RK200A-AFM	30min	200	1ph 100	50	3.2	900	1385	1250	45
					60	3.5		1120	1550	
6RK200GU-EFM	6RK200A-EFM	30min	200	1ph 110	60	2.75	850	1120	1550	35
				1ph 120		2.65				
6RK200GU-CFM	6RK200A-CFM	30min	200	1ph 220	50	1.40	1100	1385	1250	12
				1ph 230						
6RK200GU-HFM	6RK200A-HFM	30min	200	1ph 220	60	1.40	1000	1120	1550	-
				1ph 230						
6RK200GU-SFM	6RK200A-SFM	30min	200	3ph 220	50	1.20	3400	1385	1250	-
					60	1.00				

- 各种安全规格以电动机铭牌上的型号取得认定。

When the motor is approved under various safety standards, the model name on the nameplate is the approved model name.

- (T): 内藏热保护装置 (自动复位型)。在电动机因某种原因过热时会自行启动使电动机停止。
Contains a built-in thermal protector(automatic return). If a motor overheats for any reason, the thermal protector is opened and the motor stops.
- 电动机温度下降后会自行恢复运行，故在进行检查作业时请务必事先切断电源。
When the motor temperature drops, the thermal protector closes and the motor restarts. Be sure to turn the motor off before inspecting.
- 注：“-A”型号中电压为110V时，配置电容器容量以实际铭牌为准。
Note:“-A” it means the voltage 110v,the assembly capacitor vaule it is according the labe.

种类 Type

- 电动机 Motor

机型 Type	型号Model	
	齿轮轴型 Pinion Shaft	圆轴型 Round Shaft
导线型 Lead Wire Type	6RK200GU-AFM	6RK200A-AFM
	6RK200GU-EFM	6RK200A-EFM
	6RK200GU-CFM	6RK200A-CFM
	6RK200GU-HFM	6RK200A-HFM
	6RK200GU-SFM	6RK200A-SFM

- 平行轴减速器 (另售) Parallel Shaft Gearhead (Sold Separately)

减速器种类 Gearhead Type	减速器型号 Gearhead Model	减速比 Gear Ratio
长寿命●低噪音 Long Life ● Low Noise	6GU□K	3、3.6、5、6、7.5、9、 12.5、15、18、25、30、 36、50、60、75、90、 100、120、150、180、200

- 减速器型号的□中为减速比的数值
Enter the gear ratio in the box (□) within the model name

■ 装有减速器时的容许转矩 Gear Motor-Torque Table

- 减速器另售·中间减速器另售。电动机型号的□中为表示带端子箱型的记号(T)。
Gearhead and mid-gearbox can be sold separately. Enter the code that represents the terminal box type (T) in the box (□) within the model name.
- 减速品型号的□中为减速比的数值。
Enter the gear ratio in the box(□) within the model name.
- □色表示与电动机同一方向运转，其他则为相反方向。
The colored background □ indicates the same rotating direction of the motor while the rotating direction of others are opposite.
- 转速是以电动机的同步转速 (50Hz : 1500r/min、60Hz : 1800r/min) 为基准除以减速比而算出来的数值。实际转速将随负载大小变化所示数值减少2%~20%左右。
The speed is calculated by dividing the motor's synchronous speed (50Hz : 1500r/min、60Hz : 1800r/min) by the gear ratio. The actual speed is 2%~20% less than the displayed value, depending on the size of the load.

■ 容许力矩单位 Allowance Torque Unit : 上段 Upside (N.m) /下段 Belowside (kgf.cm)

类型 Type 电动机/减速机 Motor/Gearhead	减速比 Gear Ratio		3	3.6	5	6	7.5	9	12.5	15	18	25	30	36	50	60	75	90	100	120	150	180	200
	转速 Speed r/min	50Hz	500	417	300	250	200	166	120	100	83	60	50	42	30	25	20	16	15	12.5	10	8.3	7.5
6RK200GU-AF□M 6RK200GU-EF□M 6RK200GU-CF□M 6RK200GU-HF□M 6RK200GU-SF□M	6GU□K	50Hz	3.71	4.46	6.19	7.43	9.28	11.1	13.9	16.7	20.1	25.2	30.3	36.3	40	40	40	40	40	40	40	40	40
		60Hz	37.9	45.5	63.1	75.8	94.7	114	142	171	205	257	309	370	400	400	400	400	400	400	400	400	400
		50Hz	2.99	3.59	4.99	5.99	7.49	8.98	11.2	13.5	16.2	20.3	24.4	29.3	40	40	40	40	40	40	40	40	40
		60Hz	30.6	36.7	50.9	61.1	76.4	91.7	115	138	165	207	249	299	400	400	400	400	400	400	400	400	400

■ 容许悬挂负载 · 容许轴向负载 To Allow The Hoisting Of The Load Allow Axial Load

电动机 (圆轴型) → 272页 Motor(Round Shaft) → P272
 减速机 → 272页 Gearhead → P272

■ 减速机的容许负载惯性惯量 J Permissible Load Inertia J For Gearhead

→ 272页 → P272

■ 启动、制动特性 (参考值) Starting And Brake Characteristics(Reference Values)

- 单相电动机 Single-phase Motor
- 三相电动机 Three-phase Motor

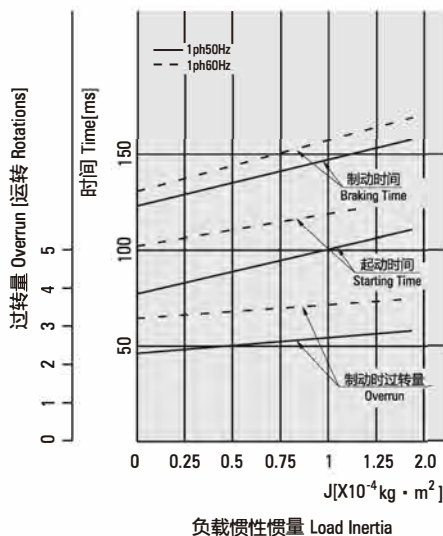
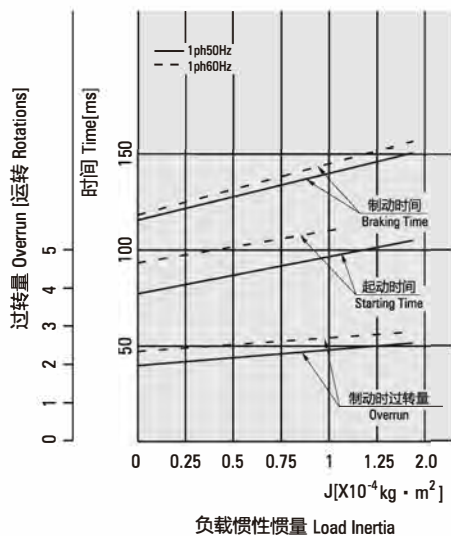

外形图 (单位 mm) Dimensions(Unit mm)

减速器附有安装用螺丝 Mounting screws are included with gearhead.

● 导线型 Lead Wiring Type

重量 Weight : 电动机 Motor : 5.9kg 减速器 Gearhead : 7.1kg

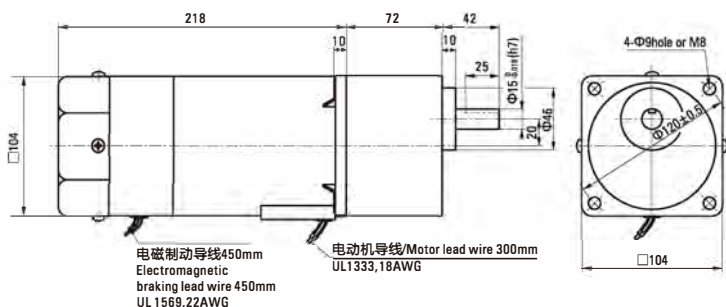

电动机型号 Motor Model	减速器型号 Gearhead Model	减速比 Gear Ratio	L1
6RK200GU-AFM 6RK200GU-EFM 6RK200GU-CFM 6RK200GU-HFM 6RK200GU-SFM	6GU□K	3~200	72

● 减速器型号的□中为减速比的数值
Enter the gear ratio in the box (□) within the model name

● 圆轴型的转轴部分 Shaft Section Of Round Shaft Type

除重量及轴部外电动机外形与齿轮轴型相同。
Excluding weight and the shaft section motor shape are the same as those of the pinion shaft type.

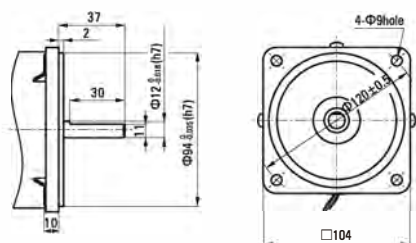

电容器外形尺寸 Formal Dimension Of Capacitor

型号 Model		电容器型号 Capacitor Model	L	W	H
齿轮轴型 Pinion Shaft	圆轴型 Round Shaft				
6RK200GU-AFM	6RK200A-AFM	ZD400CFAUL	70	38	52
6RK200GU-EFM	6RK200A-EFM	ZD300CFAUL	58	30	40
6RK200GU-CFM	6RK200A-CFM	ZD100BFAUL	58	26	38

● 常规电容器出线为引线,也可根据客户要求配置插片式187#
Note: Conventional capacitor is a lead wire type. Inserted 187# is optional

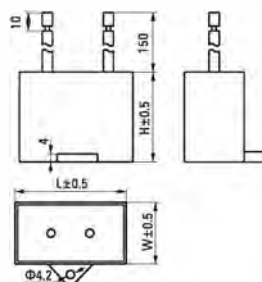

弧锥直角 SPIRAL BEVEL RIGHT ANGLE

■ 装有减速器时的容许转矩 Gear Motor-Torque Table

- 减速器 中间减速器另售。● 电动机型号的□中为表示带端子箱型的记号(T)。
Gearhead and mid-gearbox can be sold separately. Enter the code that represents the terminal box type (T) in the box (□) within the model name.
- 减速器型号的□中为减速比的数值。□色表示与电动机同一方向运转，其他则为相反方向。
Enter the gear ratio in the box (□) within the model name.
The colored background □ indicates the same rotating direction of the motor while the rotating direction of others are opposite.
- 转速是以电动机的同步转速 (50Hz:1500r/min、60Hz:1800r/min) 为基准除以减速比而算出来的数值。实际转速将随负载大小变化而比所示数值减少2%~20%左右。
The speed is calculated by dividing the motor's synchronous speed (50Hz:1500r/min、60Hz:1800r/min) by the gear ratio. The actual speed is 2%~20% less than the displayed value, depending on the size of the load.
- 希望以大于下表的减速比进行进一步减速时，可在电动机与减速器之间安装减速比为10的中间减速器。这时的容许转矩为60N·m。
To reduce the speed beyond the gear ratio in the table, attach a mid-gearbox (gear ratio:10) between the gearhead and motor. In that case, the permissible torque is 60N·m.

■ 容许力矩单位 Allowance Torque Unit: 上段 Upside (N.m) / 下段 Belowside (kgf.cm)

机型Type 电动机/减速器 Motor/Gearhead	减速比Gear Ratio	容许力矩 Allowance Torque																						
		3	3.6	5	6	7.5	9	12.5	15	18	25	30	36	50	60	75	90	100	120	150	180			
电动机/减速器 Motor/Gearhead	转速Speed r/min	50Hz	500	417	300	250	200	166	120	100	83	60	50	42	30	25	20	16	15	12	10	8		
	60Hz	600	500	360	300	240	200	144	120	100	72	60	50	36	30	24	20	18	15	12	10	10		
6RK200GU-AF□M 6RK200GU-EF□M 6RK200GU-CF□M 6RK200GU-HF□M 6RK200GU-SF□M	容许力矩 Allowance Torque	50Hz	□	3.71	4.46	6.19	7.43	9.28	11.1	13.9	16.7	20.1	25.2	30.3	36.3	50.4	60.0	60.0	60.0	60.0	60.0	60.0	60.0	
			□	37.9	45.5	63.1	75.8	94.7	114	142	171	205	257	30.9	370	515	600	600	600	600	600	600	600	600
		60Hz	□	2.99	3.59	4.99	5.99	7.49	8.98	11.2	13.5	16.2	20.3	24.4	29.3	40.7	48.8	60.0	60.0	60.0	60.0	60.0	60.0	60.0
			□	30.6	36.7	50.9	61.1	76.4	91.7	115	138	165	207	249	299	415	498	600	600	600	600	600	600	600

■ 刹车尺寸图 Brake Type Drawing

6RK200GU-AF□M/6GU□RC 6RK200GU-CF□M/6GU□RC 6RK200GU-EF□M/6GU□RC 6RK200GU-HF□M/6GU□RC 6RK200GU-SF□M/6GU□RC
 6RK200GU-AF□M/6GU□RT 6RK200GU-CF□M/6GU□RT 6RK200GU-EF□M/6GU□RT 6RK200GU-HF□M/6GU□RT 6RK200GU-SF□M/6GU□RT

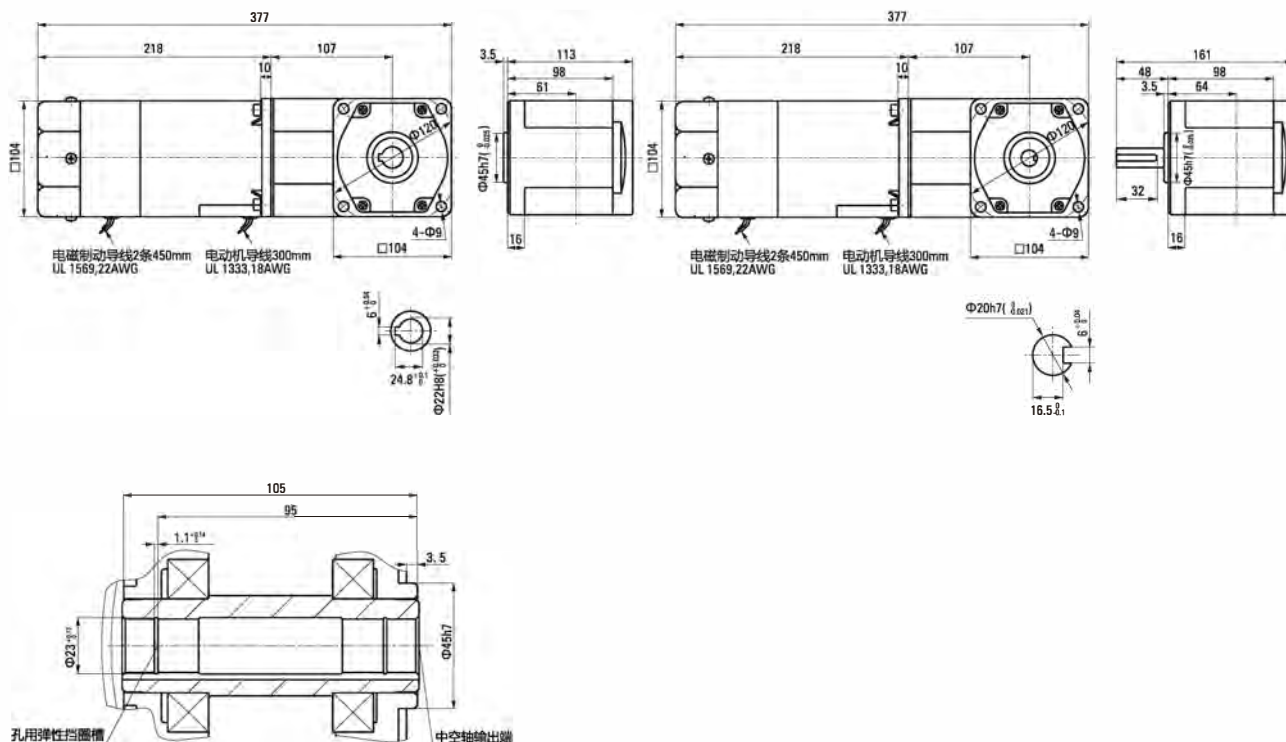



8 800 555-63-74 бесплатные звонки по РФ

Контакты

+7 (495) 505-63-74 - Москва

+7 (473) 204-51-56 - Воронеж

www.purelogic.ru

394033, Россия, г. Воронеж,
Ленинский пр-т, 160, офис 149

Пн-Чт: 8:00–17:00

Пт: 8:00–16:00

Перерыв: 12:30–13:30

info@purelogic.ru